

modular WALLCLAD OVERVIEW



modularWALLCLAD

CARVART's modularWALLCLAD is a metal paneling system that can be freely combined to create geometric designs on the wall.

modularWALLCLAD features magnetic shelves and accessories that can be freely positioned on the wall panels to create aesthetically and functionally evolving compositions.

Lighting options enhance the creative design and add depth to any environment.

INDEX

- 8** INSTALLATION
- 12** PANEL OPTIONS
- 19** ACCESSORIES

Compositions

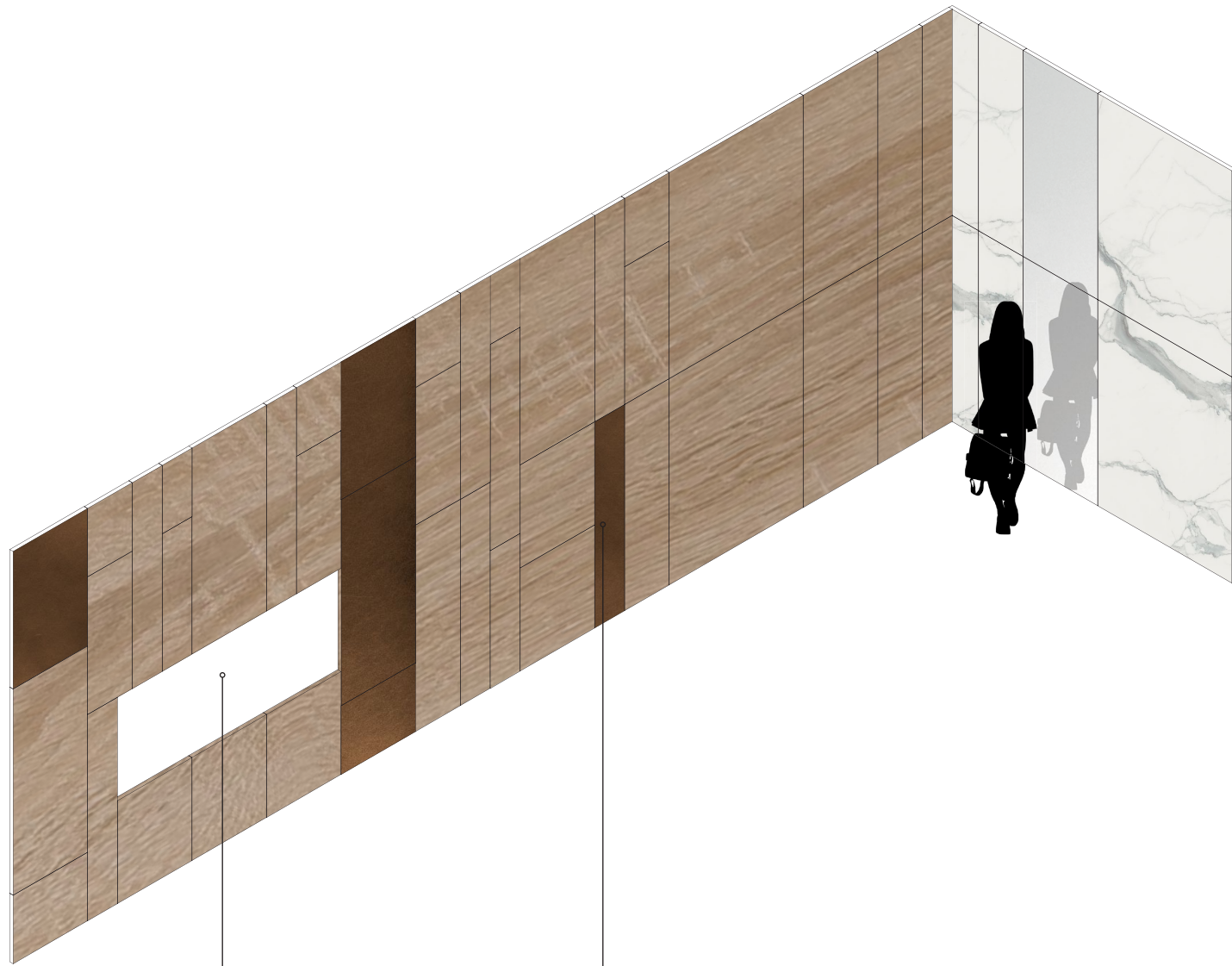

DESIGN AROUND OPENINGS
(FIRE PLACES, T.V., ETC.)

ARRANGED MOSAIC PANELS

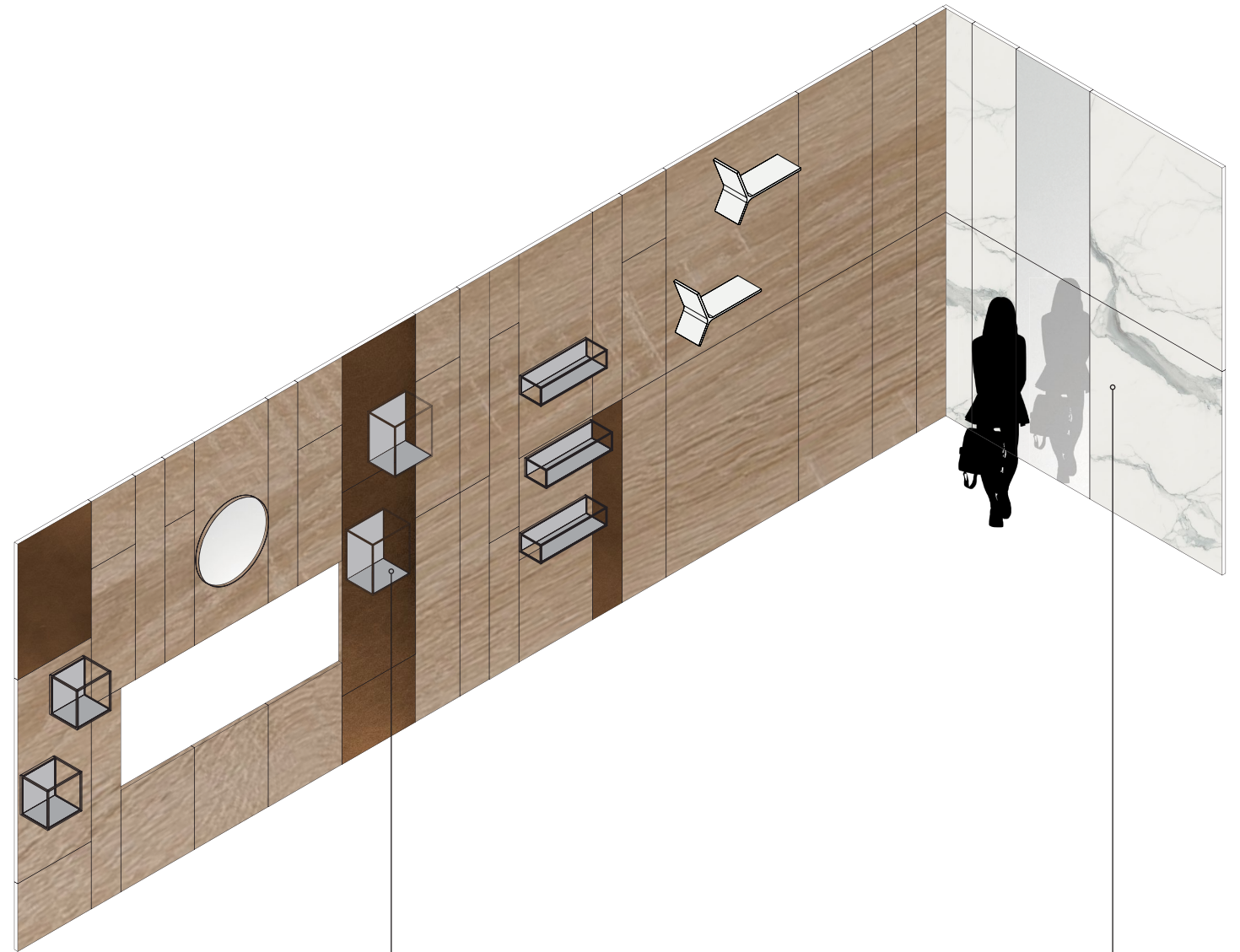

MANY ACCESSORY OPTIONS

FULL CLADDING

modularWALLCLAD Environments

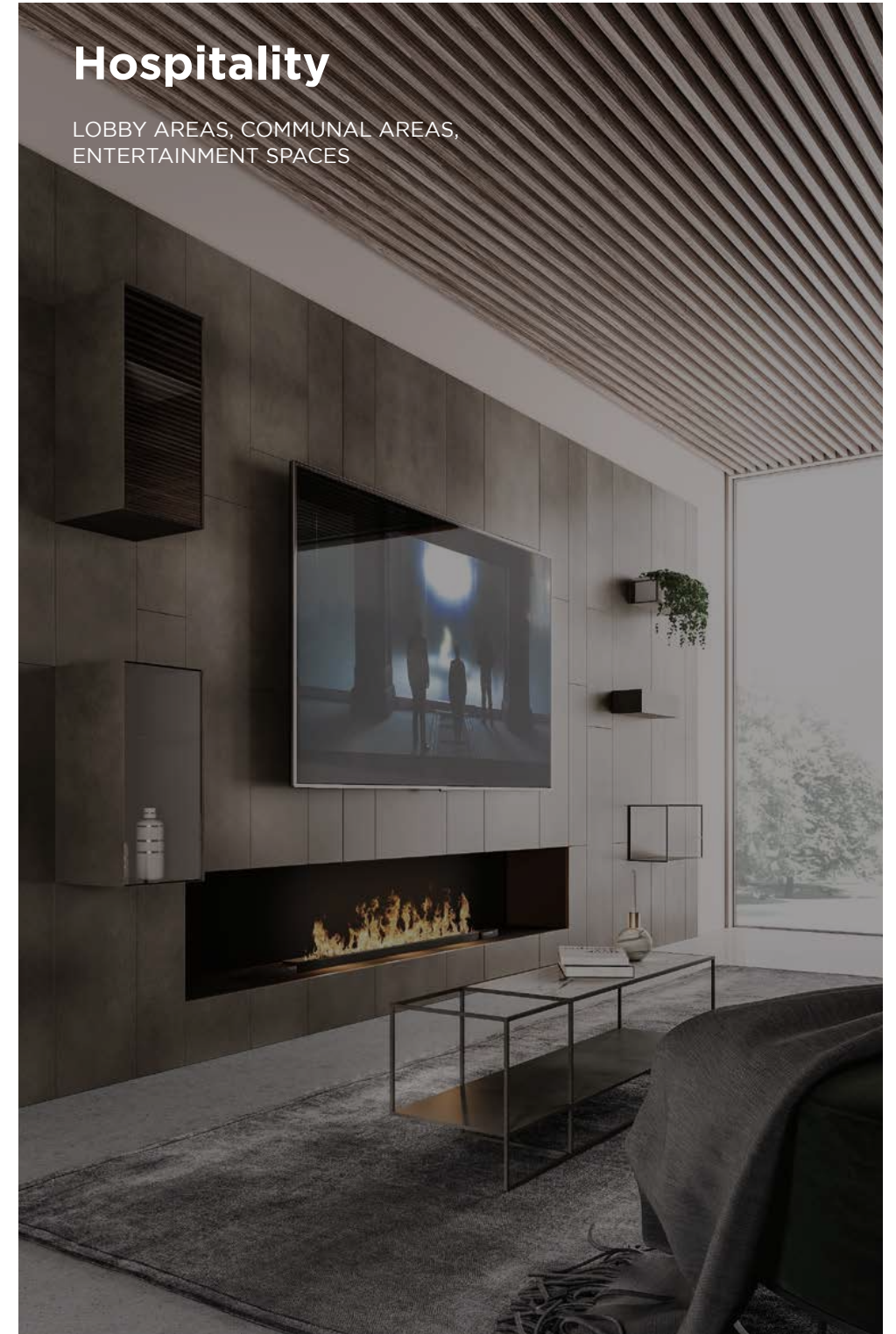
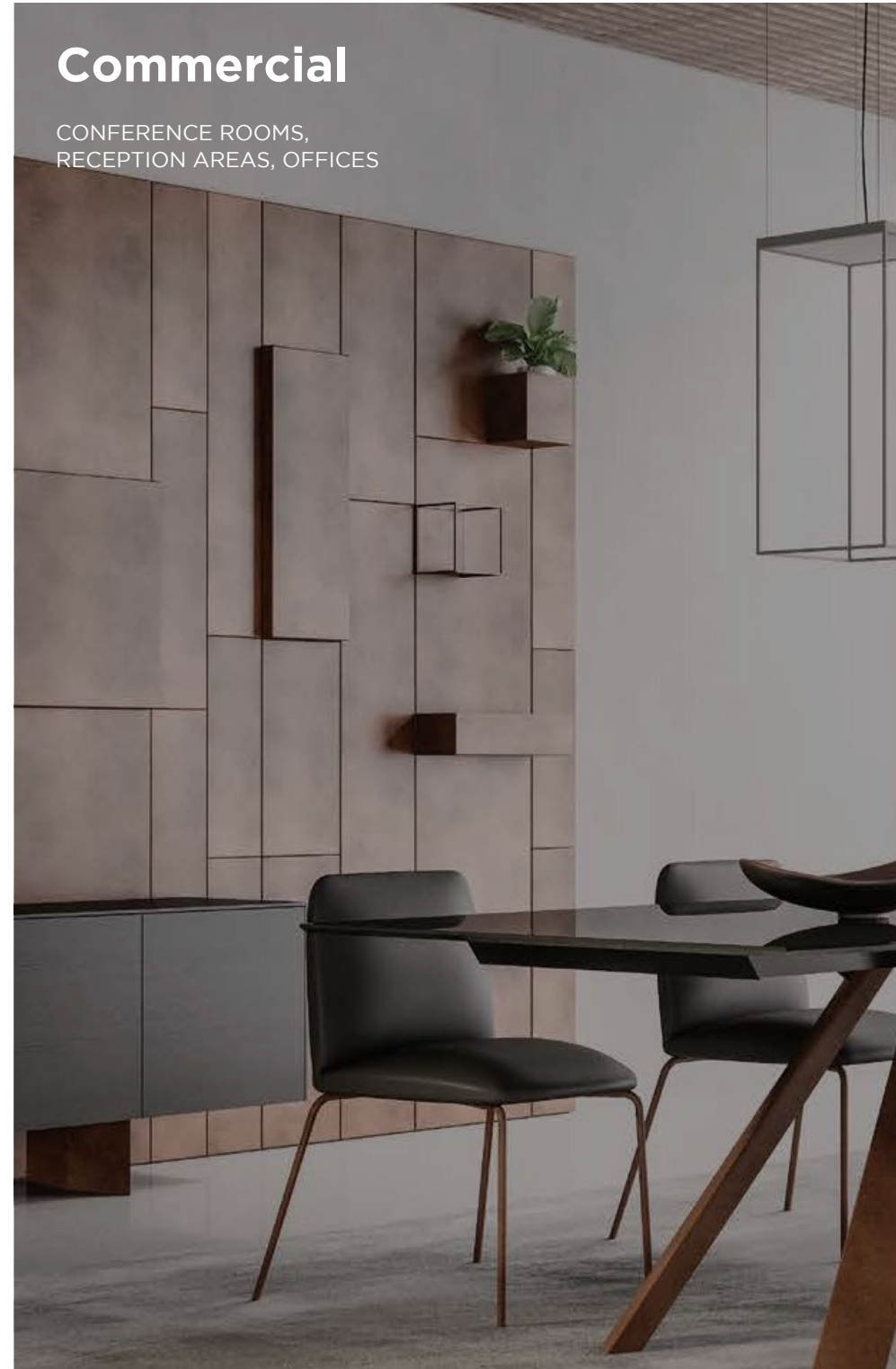

Commercial, Conference Rooms



15 Copper [Aged Liquid Varnish]
MTRO-15-ALV



lightPANEL

Hospitality, Communal Spaces

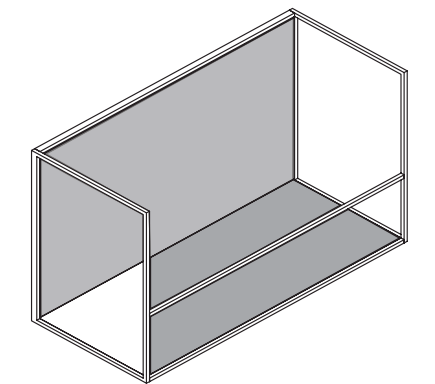

Hospitality, Entertainment Spaces

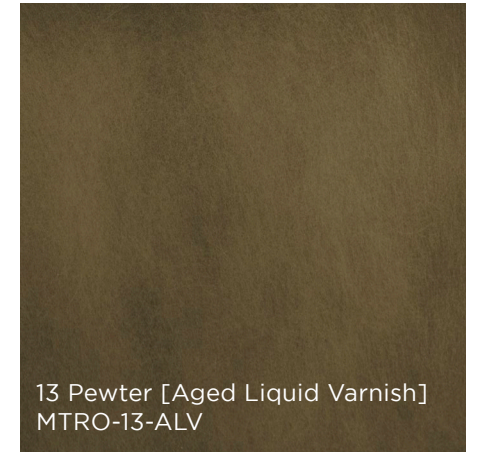

13 Pewter [Aged Liquid Varnish]
MTRO-13-ALV

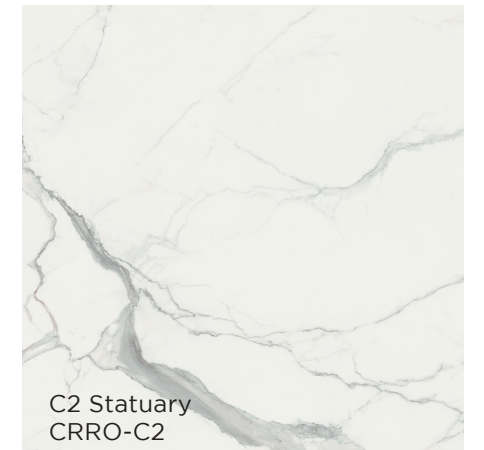

C2 Statuary
CRRO-C2

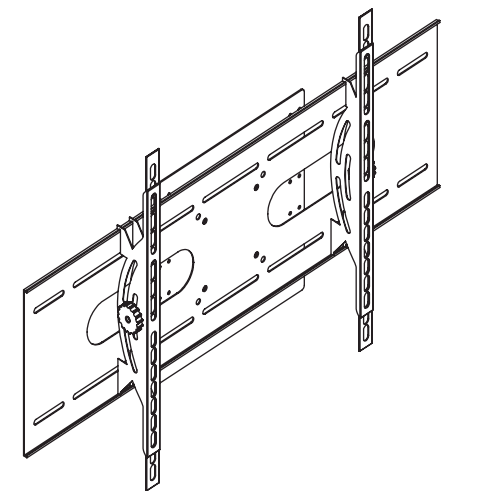

LARGE TV MOUNT



modular WALL CLAD INSTALLATION

Installation Overview

PANEL HAS SLOTS ON BACK FOR EASY AND FAST INSTALLATION

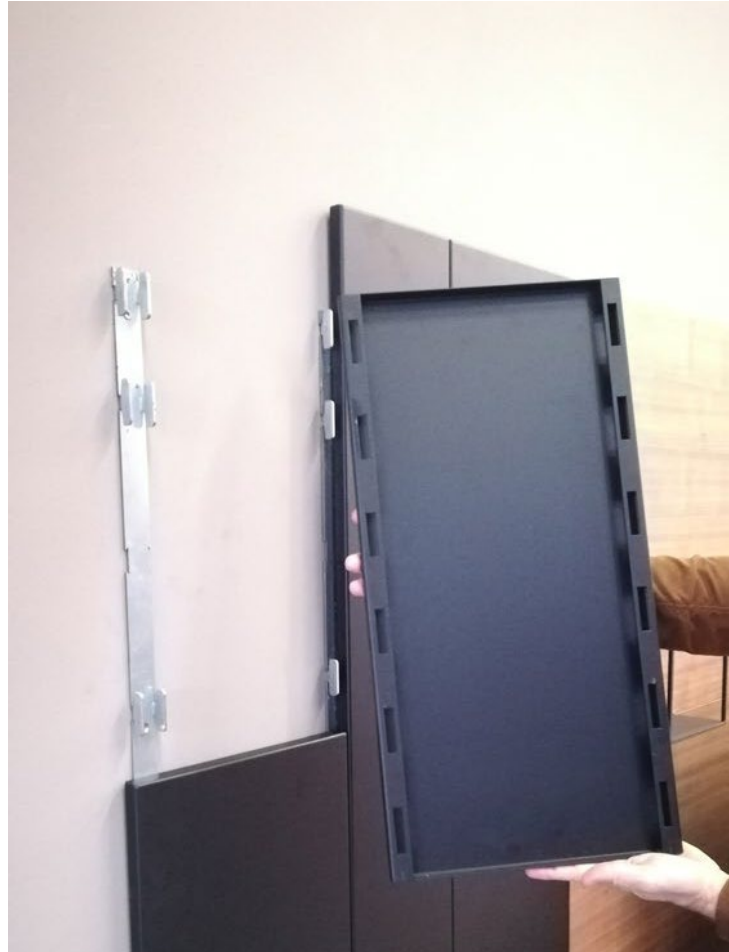

LINE UP SLOTS AND INSERT PANEL

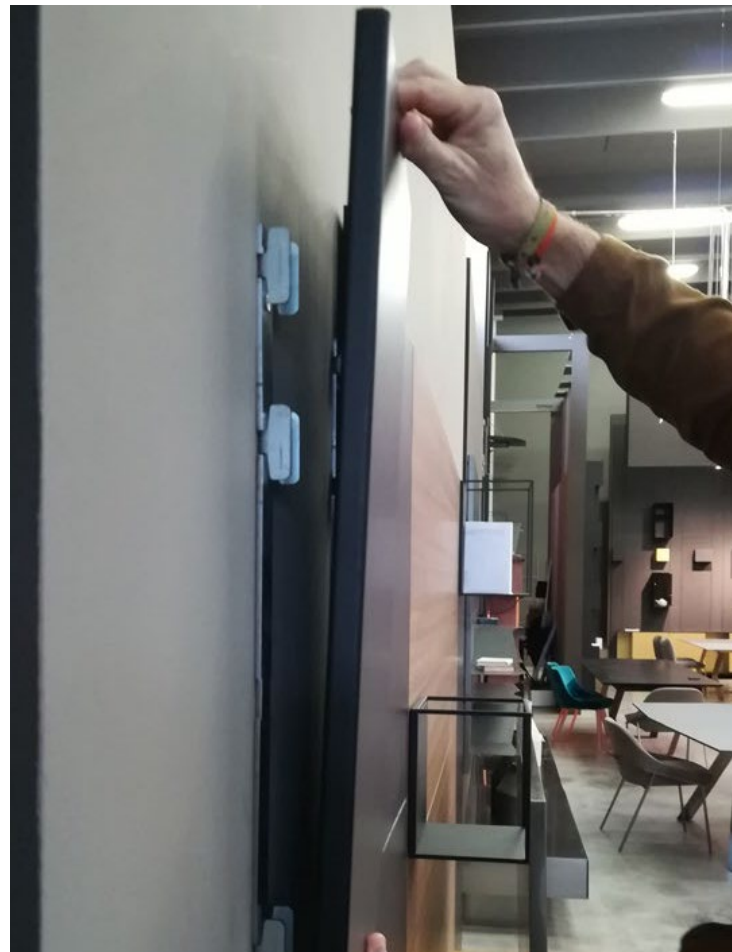

SEAMLESSLY ARRANGE WALL CLAD MATERIALS

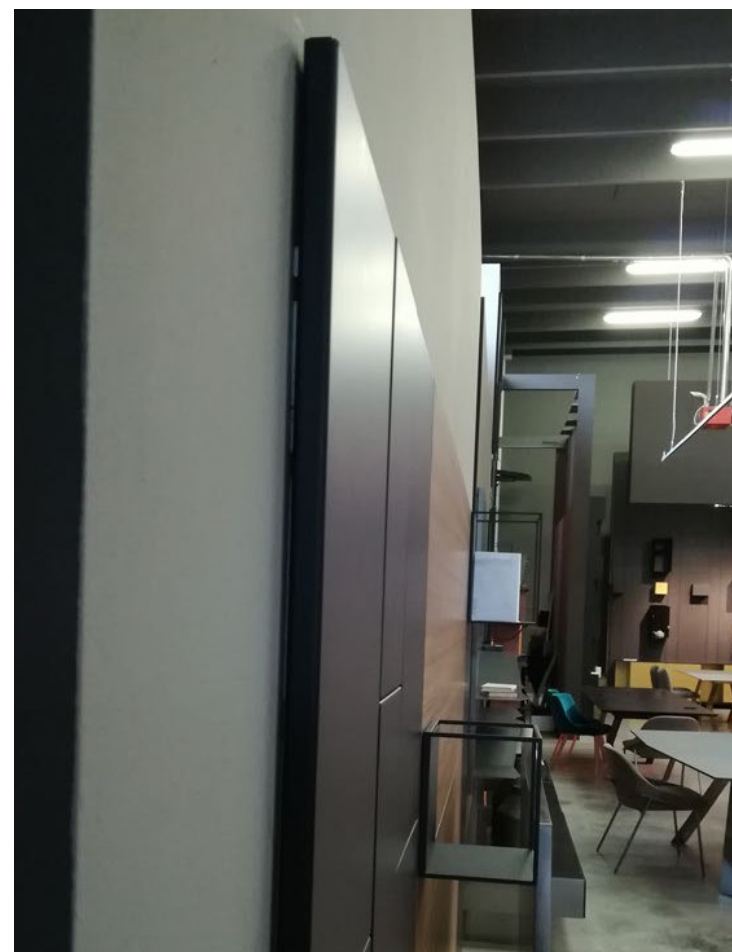

ENJOY YOUR CUSTOM WALL!

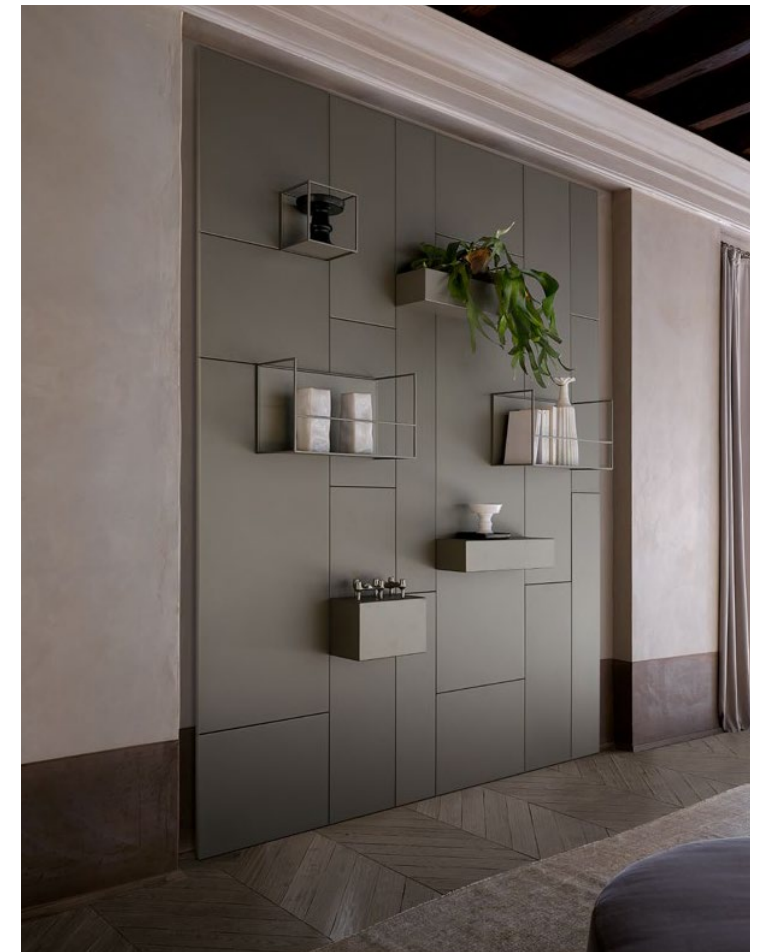

Installation Instructions

COMPONENTS

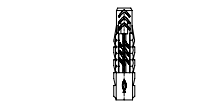

WALL ANCHOR



SCREW

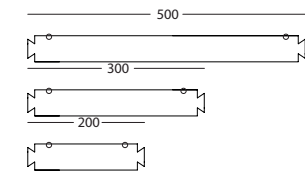

SPACER



JOINT



PANEL

MOUNTING OPTIONS

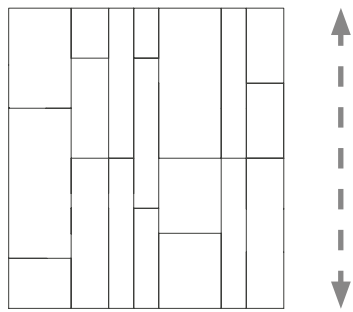

VERTICAL

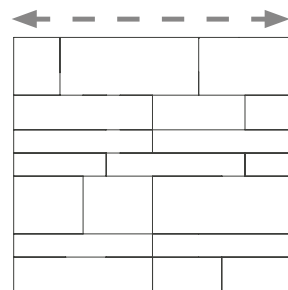

HORIZONTAL

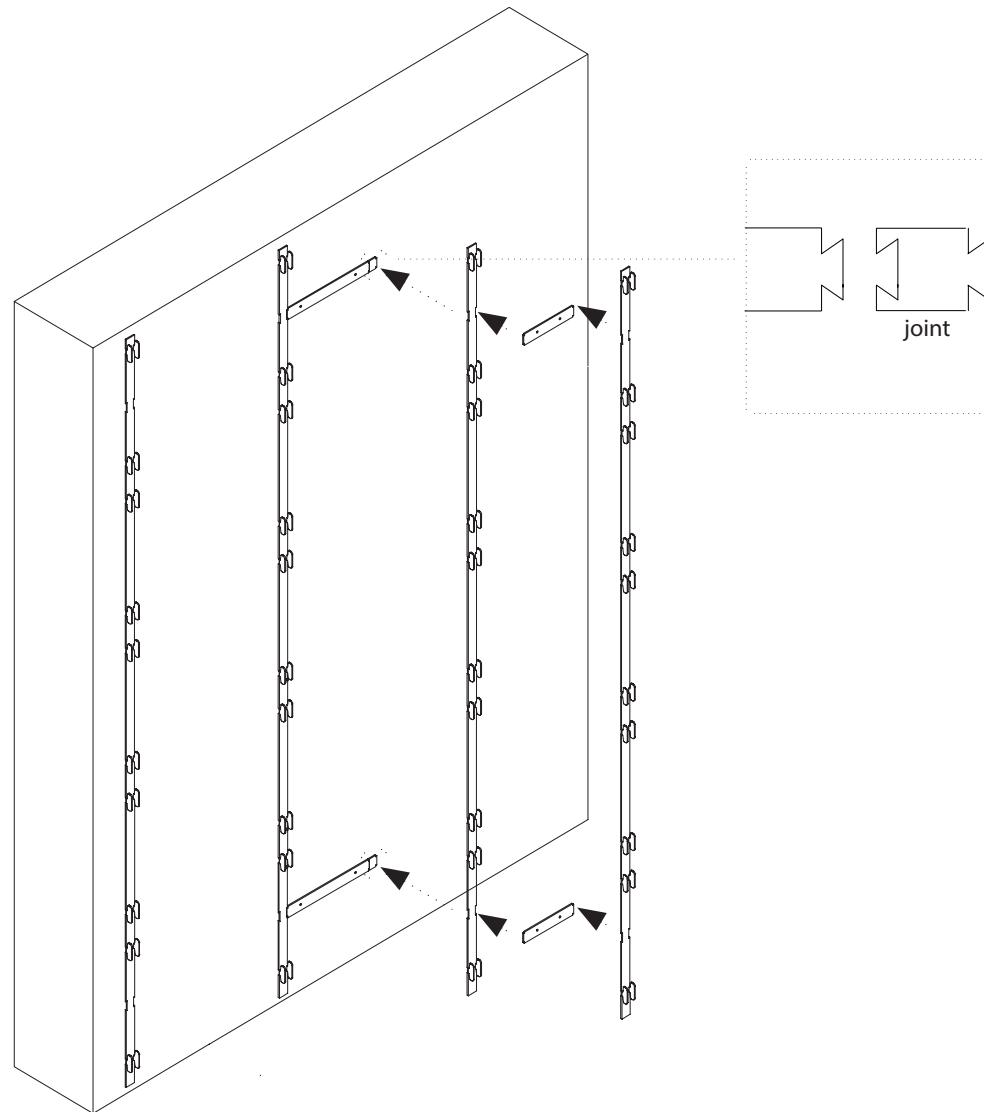

STEP 1:

- Mechanically fasten mounting strips to finished wall using a leveler
- Insert pre-fabricated spacers into joints to correctly distance mounting strips to each other.

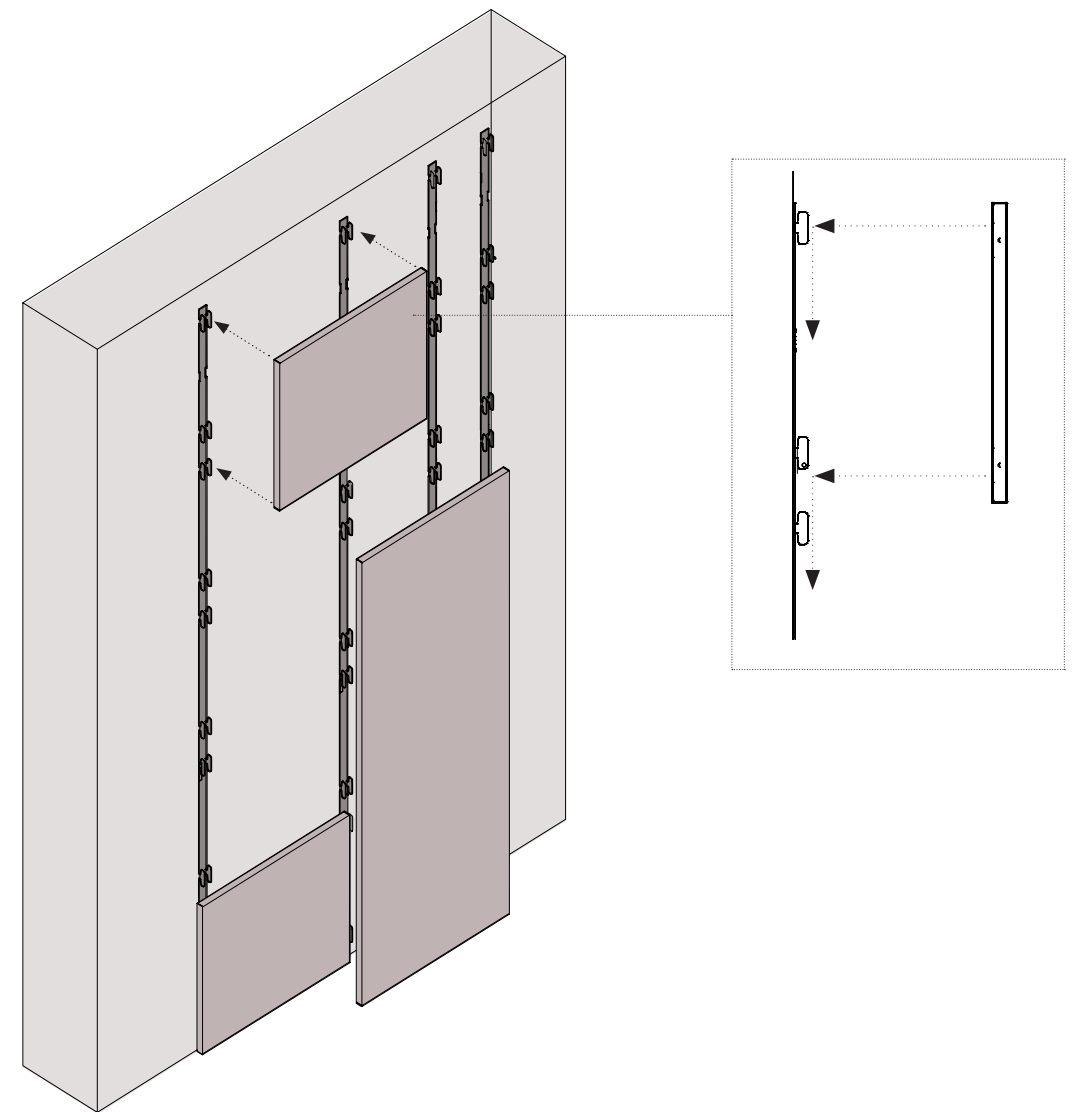

STEP 2:

- Push panels into mounting strips and push down. Installation complete.

Vertical or Horizontal Mounting



VERTICAL MOUNTING

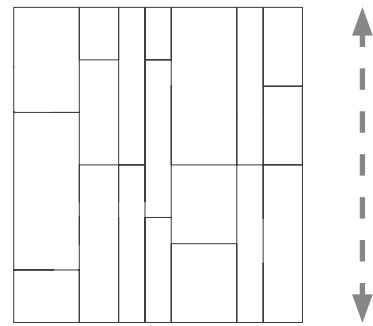

VERTICAL MOUNTING

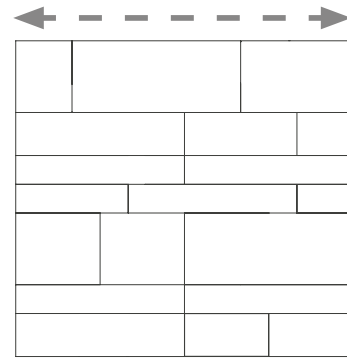
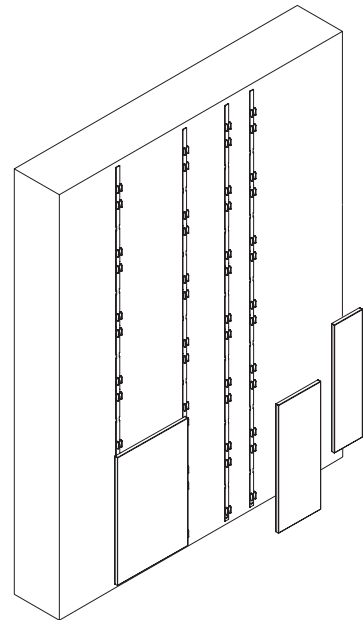

HORIZONTAL MOUNTING

OR

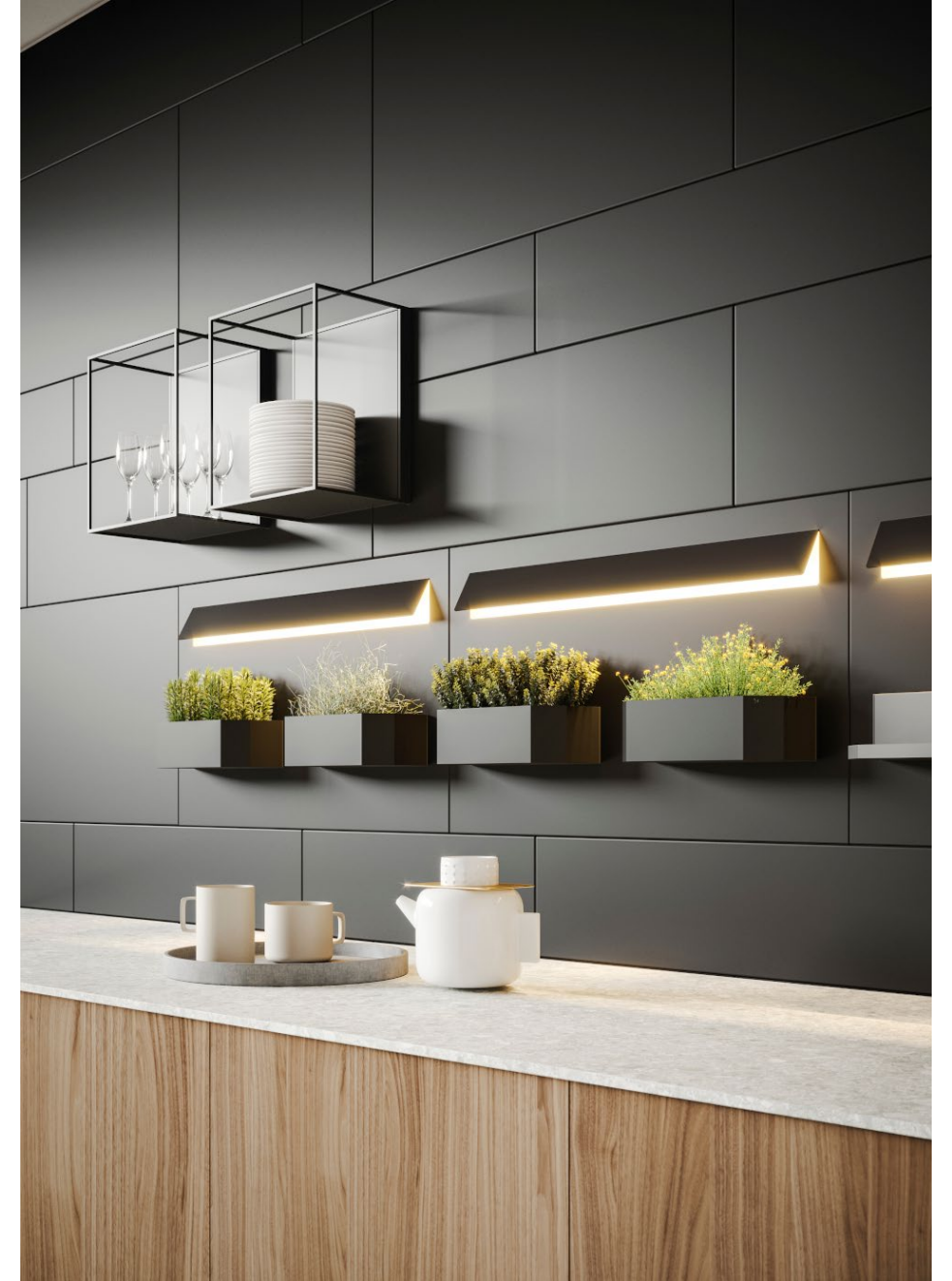
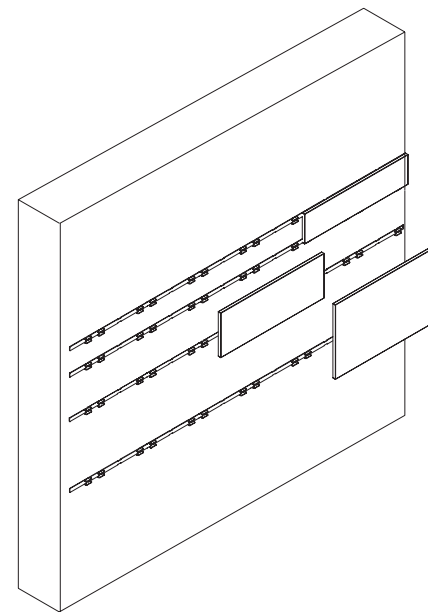

HORIZONTAL MOUNTING



How to Create your modularWALLCLAD

STEP 1

Provide opening overall size.
 Note: System is calculated in modular millimeter sizes.
 Tip: Convert sizes to mm for easy calculations.
 (Conversion to inches shown for reference on panel sizes page)

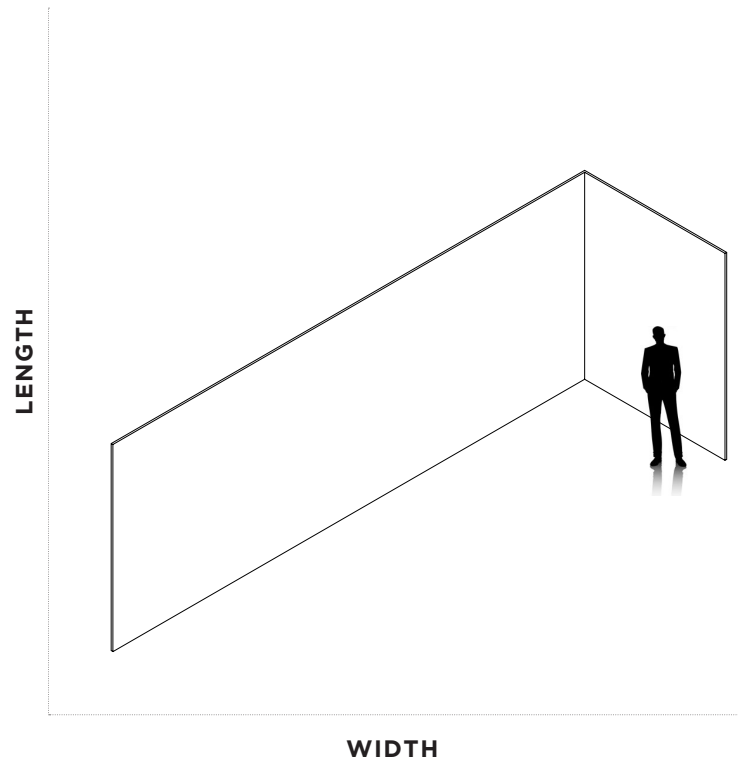

STEP 2

Create pattern with standard sizes

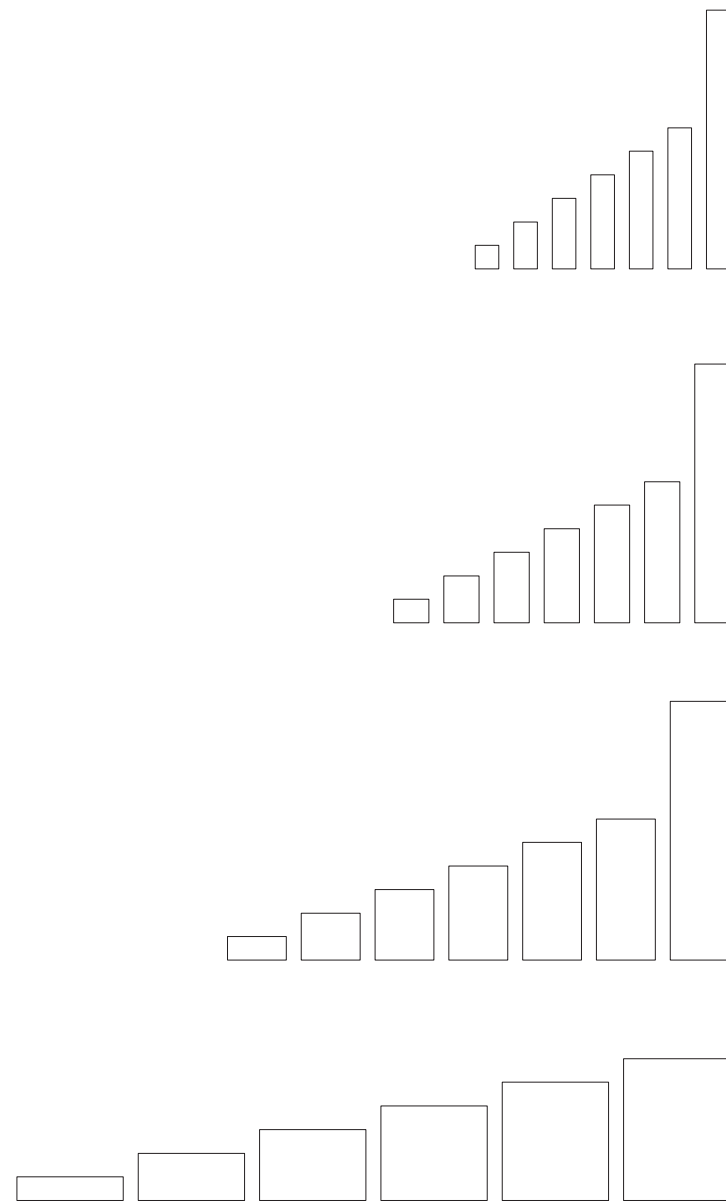

STEP 3

Build specification code
 1. Panels
 2. Accessories

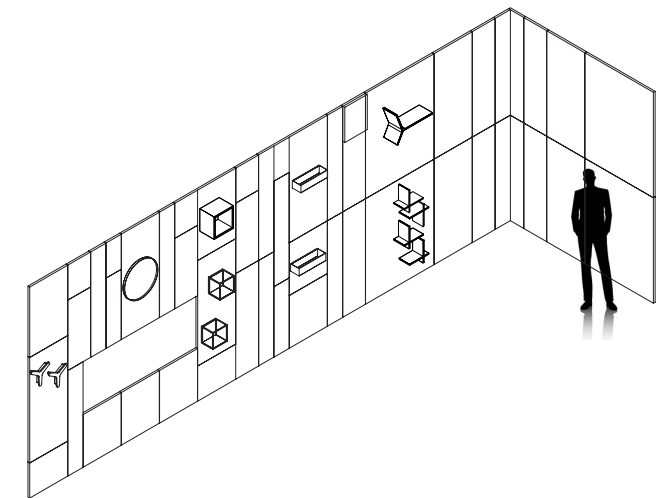

Panel Sizes

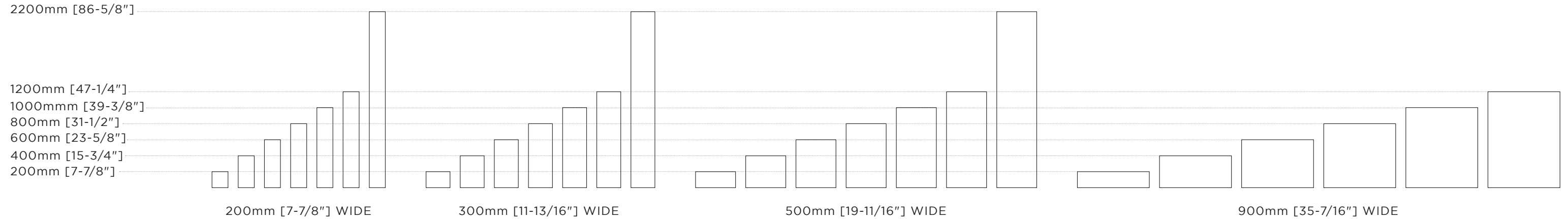

STANDARD PANEL SIZES

Panel Depth

Standard Depth:
20mm [3/4"]

Custom Depth Options:
40mm [1-9/16"]
60mm [2-3/8"]



See Finish Page for all material options

Metal end profile
3mm [1/8"] Width

WIDTHS

Panel Sizes mm [inches]	HEIGHTS						
	200 [7-7/8"]	400 [15-3/4"]	600 [23-5/8"]	800 [31-1/2"]	1000 [39-3/8"]	1200 [47-1/4"]	2200 [86-5/8"]
200 [7-7/8"]	✓	✓	✓	✓	✓	✓	✓
300 [11-13/16"]	✓	✓	✓	✓	✓	✓	✓
500 [19-11/16"]	✓	✓	✓	✓	✓	✓	✓
900 [35-7/16"]	✓	✓	✓	✓	✓	✓	✗

LIGHT PANELS

LIGHT PANEL TYPES

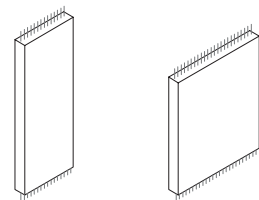

LIGHT PANELS
Depth: 60mm [2-3/8"]

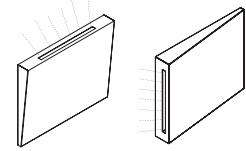

TILT LIGHT PANELS
Depth: 80mm [3-1/8"]



LASER CUT LIGHT PANELS
Depth: 60mm [2-3/8"]

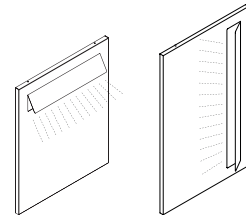

POST LIGHT PANELS
Depth: 60mm [2-3/8"]

LIGHT PANELS
DEPTH: 60mm [2-3/8"]

POST LIGHT PANEL
DEPTH: 20mm [3/4"]

LASER CUT PANEL
DEPTH: 60mm [2-3/8"]

TILTED LIGHT PANEL
TOP TO BOTTOM, BOTTOM TO TOP
LEFT TO RIGHT, RIGHT TO LEFT
DEPTH: 20mm [3/4"] to 80mm [3-1/8"]

Light Panel Sizes mm [inches]	HEIGHTS		
	400 [15-3/4"]	600 [23-5/8"]	800 [31-1/2"]
300 [11-13/16"]			✓
500 [19-11/16"]		✓	
500 [19-11/16"]		✓	✓
500 [19-11/16"]		✓	
500 [19-11/16"]	✓		

Panel Vertical Sections

METAL PANEL Magnetic Accessory Type 1

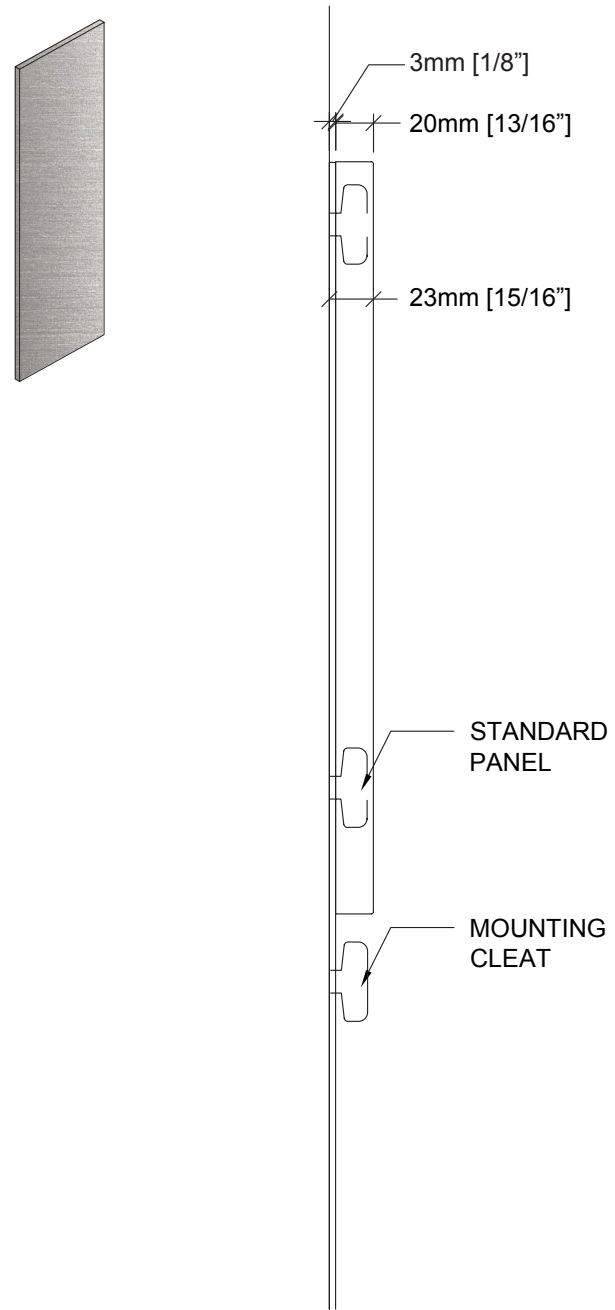

ADDITIONAL MATERIAL PANEL Magnetic Accessory Type 2

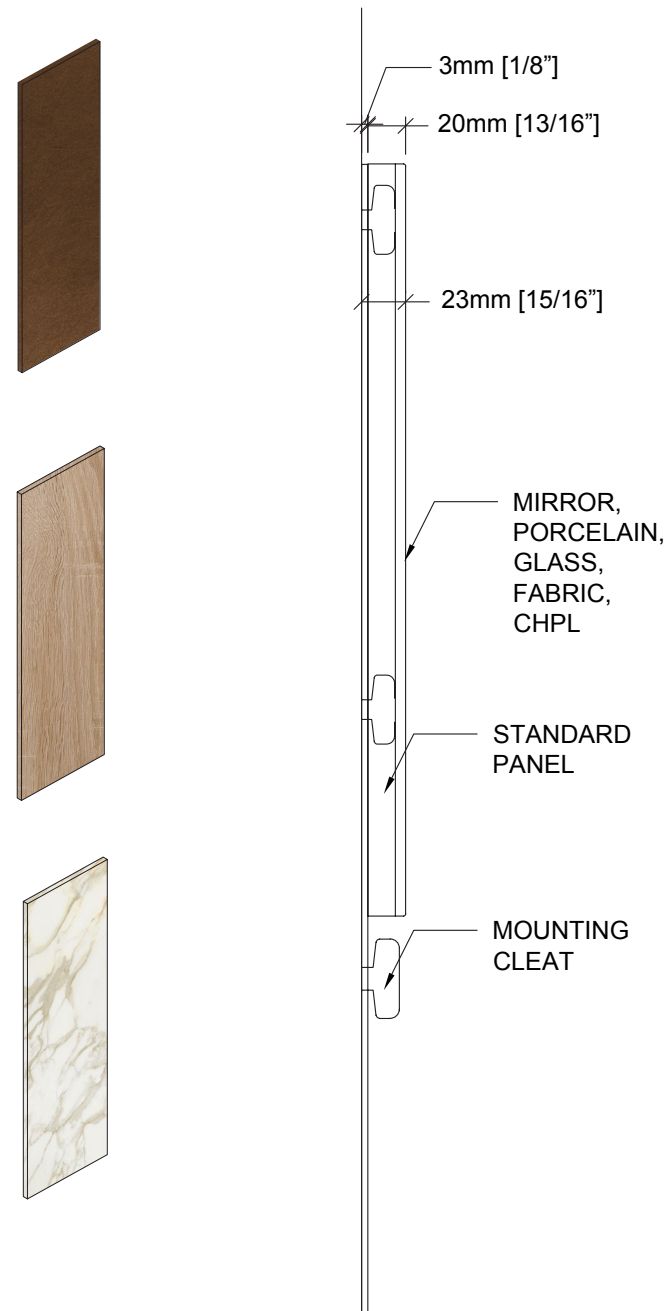

LIGHT PANEL Depth: 63mm [2-1/2"]

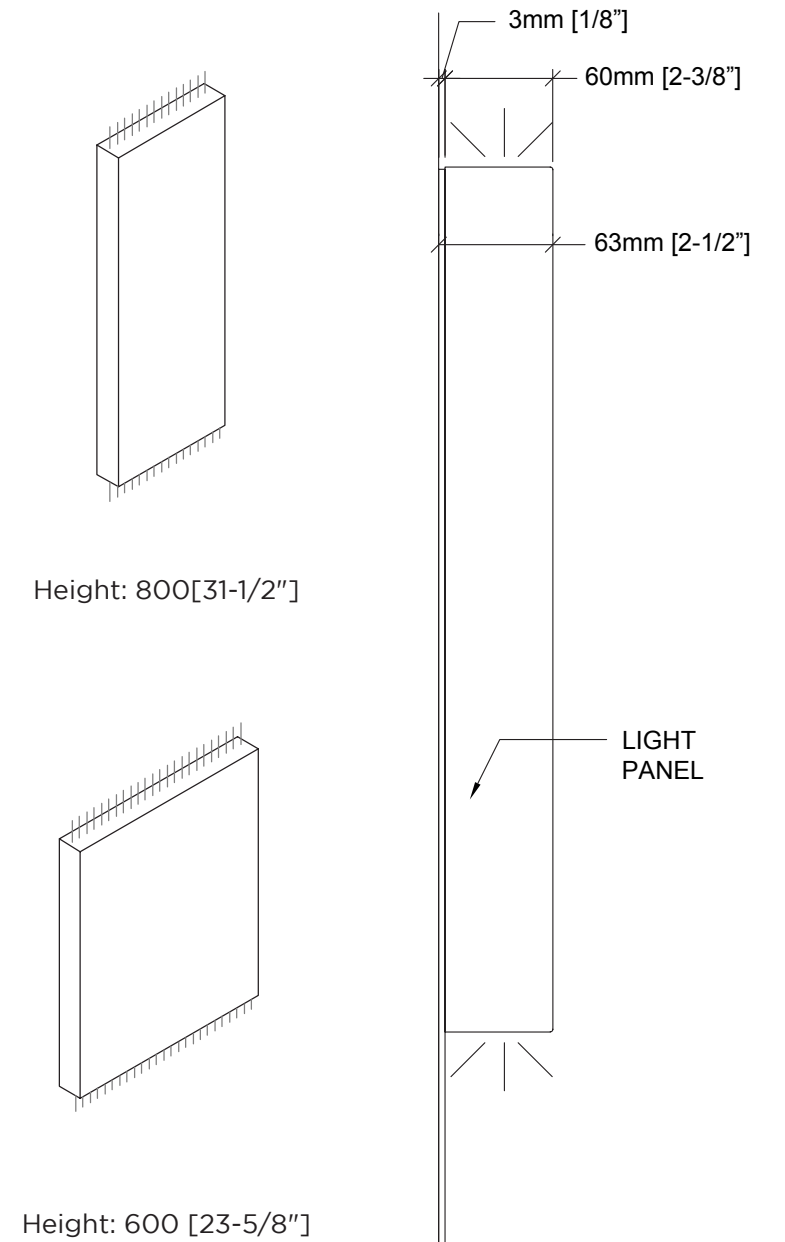

modularWALLCLAD Panel Finishes

Metals Powder Coated Varnished

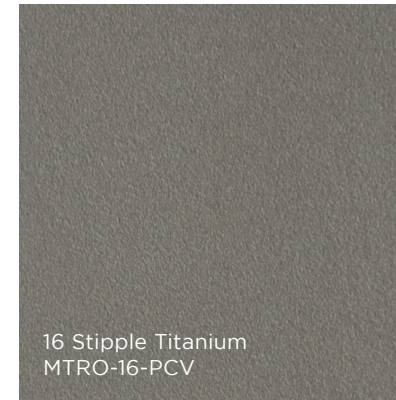
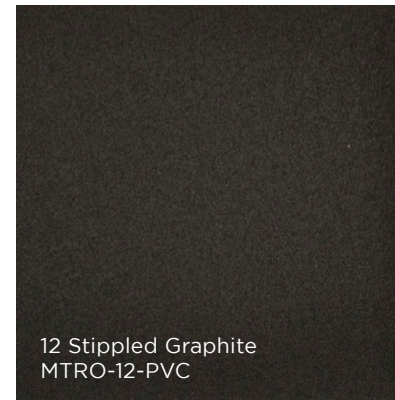

Metals Aged Liquid Varnished



Veneers



modularWALLCLAD Panel Finishes
Ceramics



C1 White Calacatta
CRRO-C1

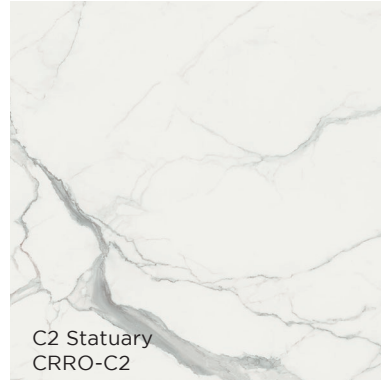

C2 Statuary
CRRO-C2



C3 Marquinia Black
CRRO-C3

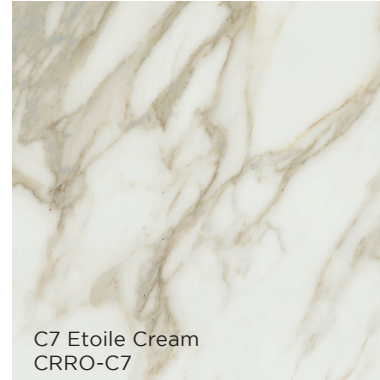

C7 Etoile Cream
CRRO-C7

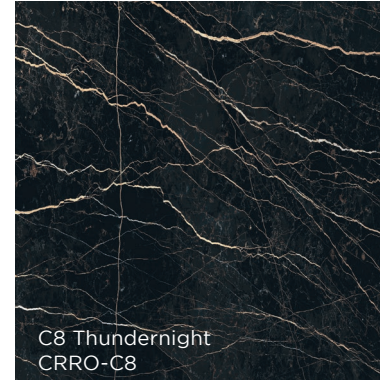

C8 Thundernight
CRRO-C8

Mirror



SP Mirror
MRRO-SP



SG Grey Mirror
MRRO-SG

Glass

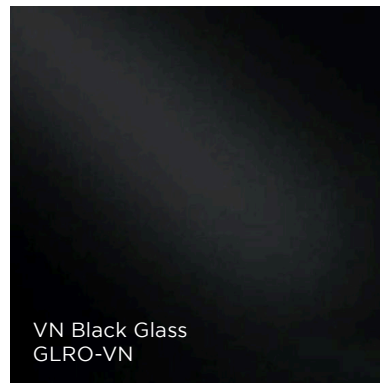

VN Black Glass
GLRO-VN



VB White Glass
GLRO-VB



RAL Colors
GLRO-RAL

OVERVIEW

CERAMICS: Ceramics C1 and C2 are only available on panels 2200mm [86-5/8"] height.

GLASS: Glass available in Black, White and any RAL Colors.

Chpl: Available in solid colors and wood grain prints, see CARVART Materials at CARVART.com

Additional Panel Options

LIGHT PANELS

Fixed LED light panel with diffused LED lights connected via low voltage connections. See varying design options

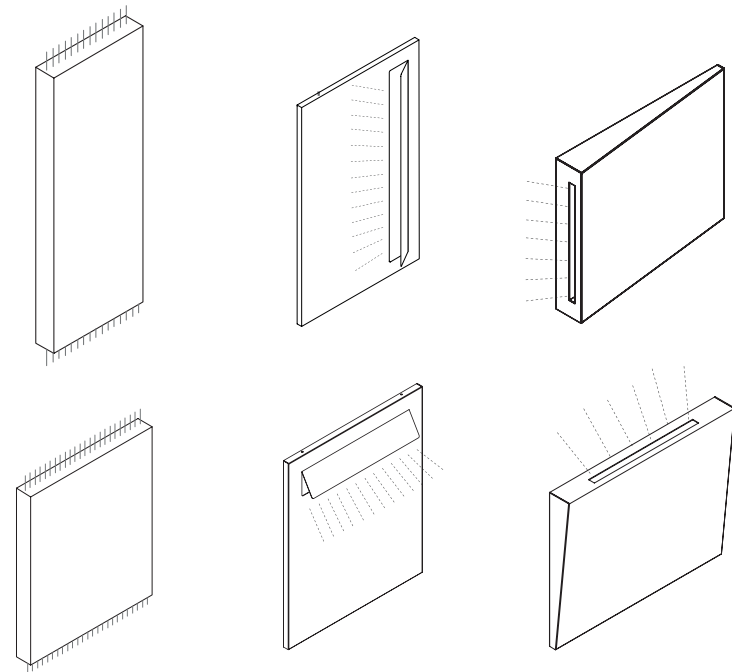

FINISH OPTIONS:

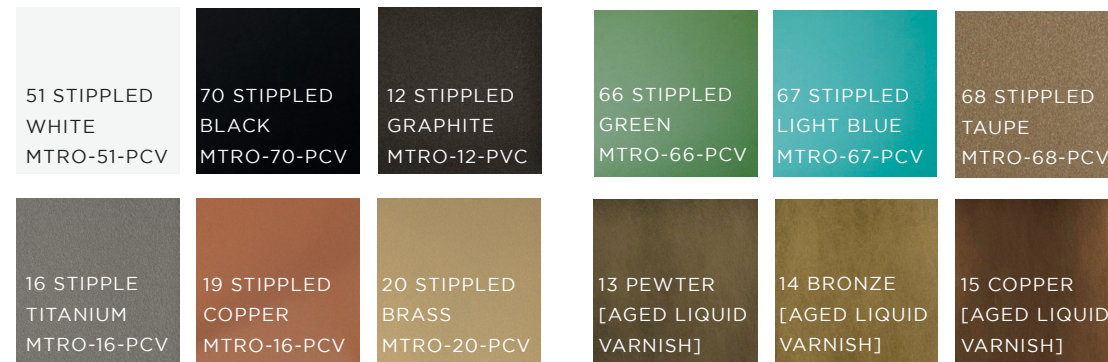

METAL PERFORATED PANELS

Fixed painted metal panels with micro perforations. Filled with recycled polyester fibers resulting in sound absorption properties.

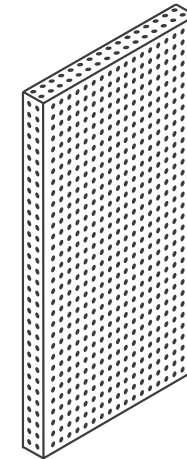

FINISH OPTIONS:



acousticPANEL > Perforated

CY-

Fixed painted metal panels with micro perforations. Filled with recycled polyester fibers resulting in sound absorption properties.

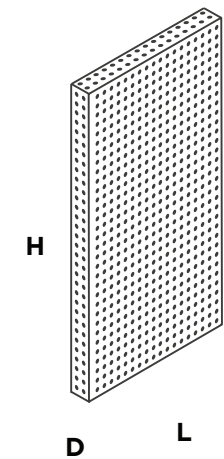

DETAILS

- (90) Width 300mm [11-13/16"] x Height 600mm [23-5/8"]
- (91) Width 300mm [11-13/16"] x Height 800mm [31-1/2"]
- (92) Width 300mm [11-13/16"] x Height 1200mm [47-1/4"]
- (93) Width 500mm [19-11/16"] x Height 600mm [23-5/8"]
- (94) Width 500mm [19-11/16"] x Height 800mm [31-1/2"]
- (95) Width 5 00mm [19-11/16"] x Height 1200mm [47-1/4"]

Depth: 40mm [1-9/16"]

Panel is fixed and cannot accept accessories

EXAMPLE SPECIFICATION CODE: **CY-90-51**

CY	SELECT SIZE OPTION	SELECT FINISH OPTION
LINE	SIZE	FINISH

FINISH OPTIONS:

51 STIPPLED WHITE MTRO-51-PCV	70 STIPPLED BLACK MTRO-70-PCV	12 STIPPLED GRAPHITE MTRO-12-PVC	66 STIPPLED GREEN MTRO-66-PCV	67 STIPPLED LIGHT BLUE MTRO-67-PCV	68 STIPPLED TAUPE MTRO-68-PCV
16 STIPPLE TITANIUM MTRO-16-PCV	19 STIPPLED COPPER MTRO-16-PCV	20 STIPPLED BRASS MTRO-20-PCV			



Lighting Panels Wiring

Wire together LED Light Panels with low-voltage wires, and connect to power transformers. Conceal components and wiring behind panels.

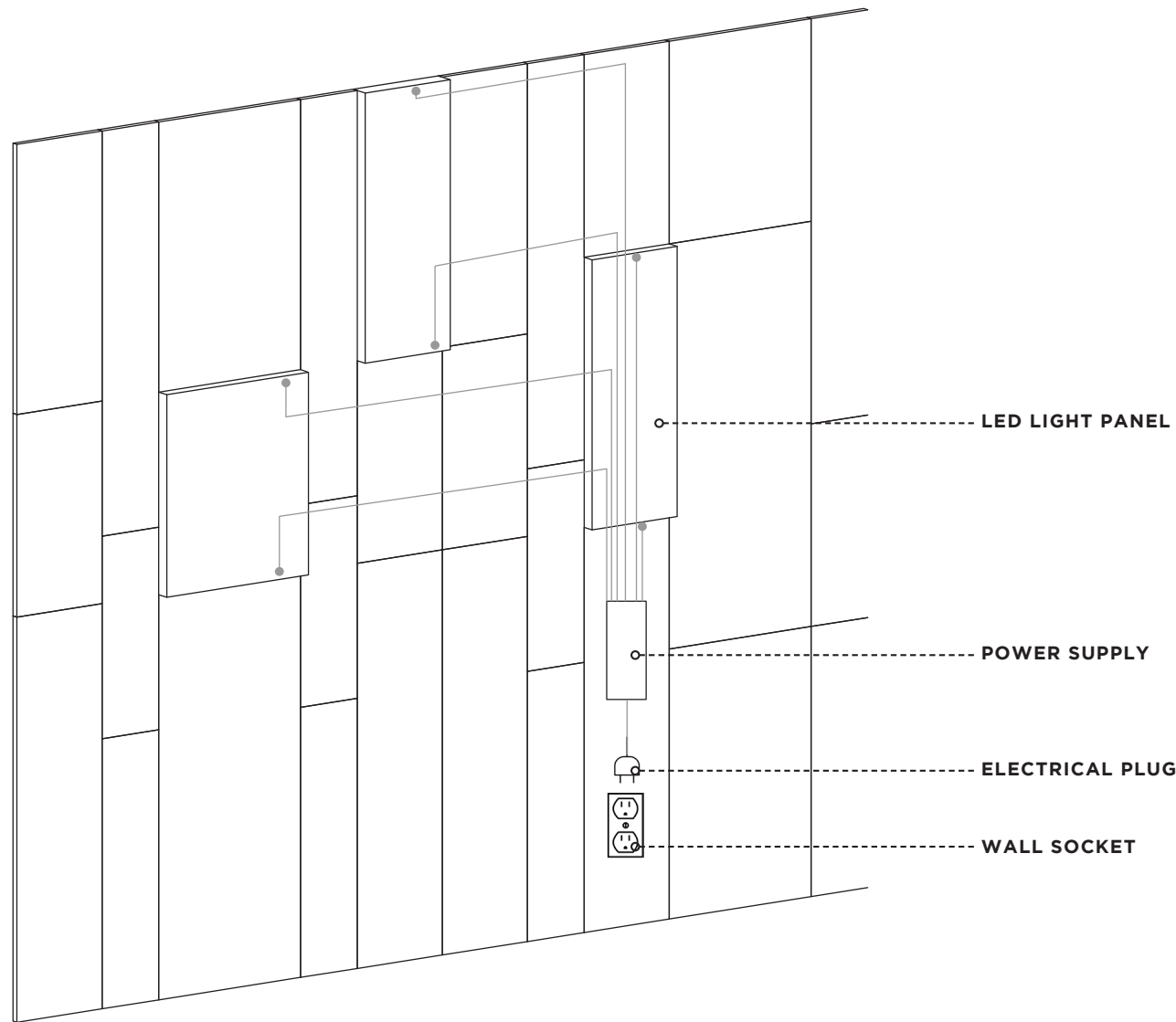

COMPONENTS

Simple, industry standard, low voltage components, wired to building power. Provide CARVART with your electrical design considerations for recommendations on installation.



12 VOLT DC POWER SUPPLY
100V - 240V AC to 12V DC LED Low Voltage Transformer. IP 67 Waterproof Converter Constant Voltage LED Driver for Lightings (30 Watts)



WIRE CONNECTIONS
Low voltage pin connectors for easy installation. No soldering components.

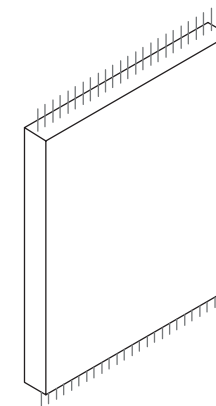

LED LIGHT PANEL
Choose from a variety of different fixed light panel options that use low voltage LEDs



US POWER PLUG
Plug directly into standard 110/120V U.S. standard building power.

lightPANEL

CY--

Fixed LED light panel with diffused light from the top and bottom of the panel.

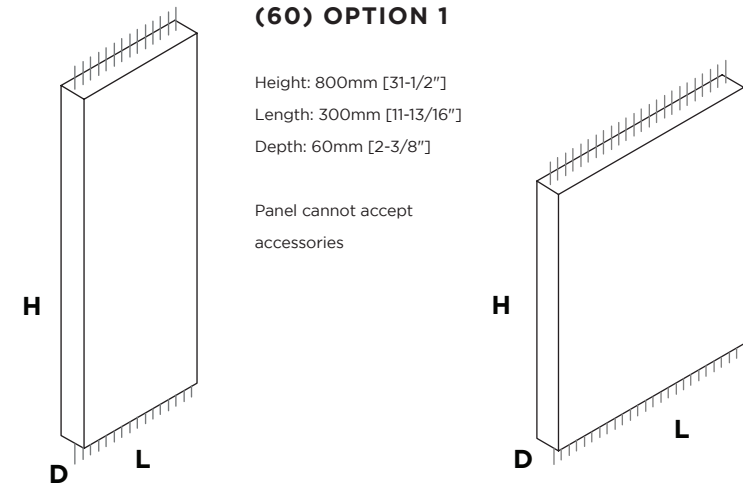

(60) OPTION 1

Height: 800mm [31-1/2"]
 Length: 300mm [11-13/16"]
 Depth: 60mm [2-3/8"]

Panel cannot accept accessories

(61) OPTION 2

Height: 600mm [23-5/8"]
 Length: 500mm [19-11/16"]
 Depth: 60mm [2-3/8"]

Panel cannot accept accessories

EXAMPLE SPECIFICATION CODE: **CY-60-51**

CY	60	SELECT FINISH OPTION
	61	
LINE	TYPE	MODEL/ID

FINISH OPTIONS:

51 STIPPLED WHITE MTRO-51-PCV	70 STIPPLED BLACK MTRO-70-PCV	12 STIPPLED GRAPHITE MTRO-12-PVC	66 STIPPLED GREEN MTRO-66-PCV	67 STIPPLED LIGHT BLUE MTRO-67-PCV	68 STIPPLED TAUPE MTRO-68-PCV
16 STIPPLE TITANIUM MTRO-16-PCV	19 STIPPLED COPPER MTRO-16-PCV	20 STIPPLED BRASS MTRO-20-PCV	13 PEWTER [AGED LIQUID VARNISH]	14 BRONZE [AGED LIQUID VARNISH]	15 COPPER [AGED LIQUID VARNISH]



lightPANEL > Tilt

CY--

Fixed LED light panel that tapers in depth, with diffused light from the top and bottom of the panel.

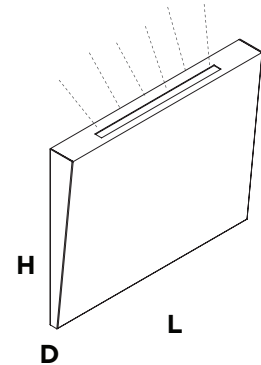

OPTION 1

Height: 400mm [15-3/4"]
 Length: 500mm [19-11/16"]
 Depth: 20mm [3/4"] to 60 mm [2-3/8"]

Light Options:
 (82) No LED
 (84) LED

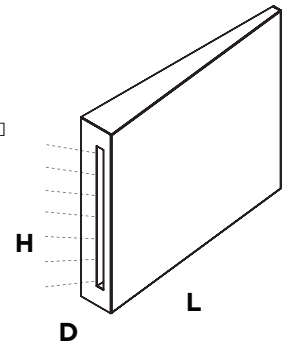

OPTION 2

Height: 400mm [15-3/4"]
 Length: 500mm [19-11/16"]
 Depth: 20mm [3/4"] to 60 mm [2-3/8"]

Light Options:
 (81) No LED
 (83) LED

EXAMPLE SPECIFICATION CODE: **CY-82-51**

CY	SELECT LIGHT OPTION	SELECT FINISH OPTION
LINE	TYPE	MODEL/ID

FINISH OPTIONS:

51 STIPPLED WHITE MTRO-51-PCV	70 STIPPLED BLACK MTRO-70-PCV	12 STIPPLED GRAPHITE MTRO-12-PVC	66 STIPPLED GREEN MTRO-66-PCV	67 STIPPLED LIGHT BLUE MTRO-67-PCV	68 STIPPLED TAUPE MTRO-68-PCV
16 STIPPLE TITANIUM MTRO-16-PCV	19 STIPPLED COPPER MTRO-16-PCV	20 STIPPLED BRASS MTRO-20-PCV	13 PEWTER [AGED LIQUID VARNISH]	14 BRONZE [AGED LIQUID VARNISH]	15 COPPER [AGED LIQUID VARNISH]



lightPANEL > Post

CY--

Fixed LED light panel with post opening angling light downwards or to the side.

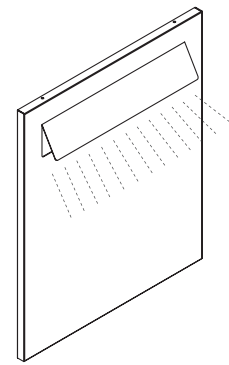

(69) OPTION 1

Height: 600mm [23-5/8"]
Length: 500mm [19-11/16"]
Depth: 20mm [3/4"]

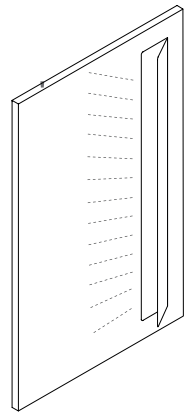

(79) OPTION 2

Height: 800mm [31-1/2"]
Length: 500mm [19-11/16"]
Depth: 20mm [3/4"]

EXAMPLE SPECIFICATION CODE: **CY-69-51**

CY	69	SELECT FINISH OPTION
	79	
LINE	TYPE	MODEL/ID

FINISH OPTIONS:

51 STIPPLED WHITE MTR0-51-PCV	70 STIPPLED BLACK MTR0-70-PCV	12 STIPPLED GRAPHITE MTR0-12-PVC	66 STIPPLED GREEN MTR0-66-PCV	67 STIPPLED LIGHT BLUE MTR0-67-PCV	68 STIPPLED TAUPE MTR0-68-PCV
16 STIPPLE TITANIUM MTR0-16-PCV	19 STIPPLED COPPER MTR0-16-PCV	20 STIPPLED BRASS MTR0-20-PCV	13 PEWTER [AGED LIQUID VARNISH]	14 BRONZE [AGED LIQUID VARNISH]	15 COPPER [AGED LIQUID VARNISH]





C8 Thundernight
CRRO-C8



20 Stippled Brass
MTRO-20-PCV

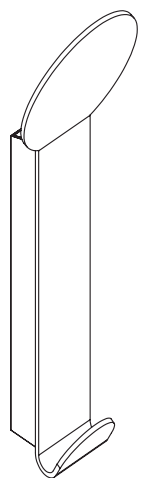

CLOTHING HOOK

PANEL ACCESSORIES



Magnetic Accessories

Combine modular WALLCLAD materials with beautifully designed accessories for near infinite combinations.

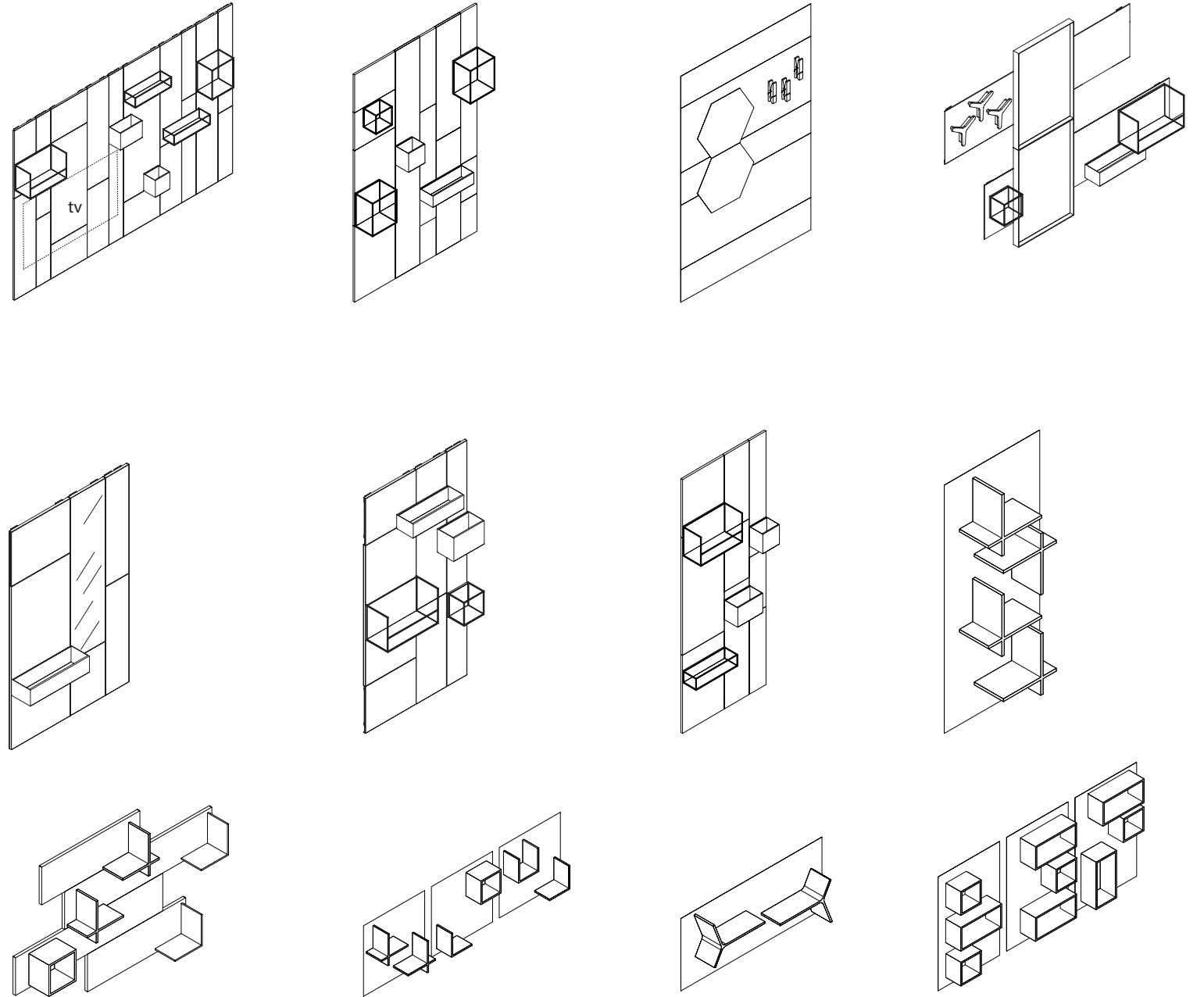
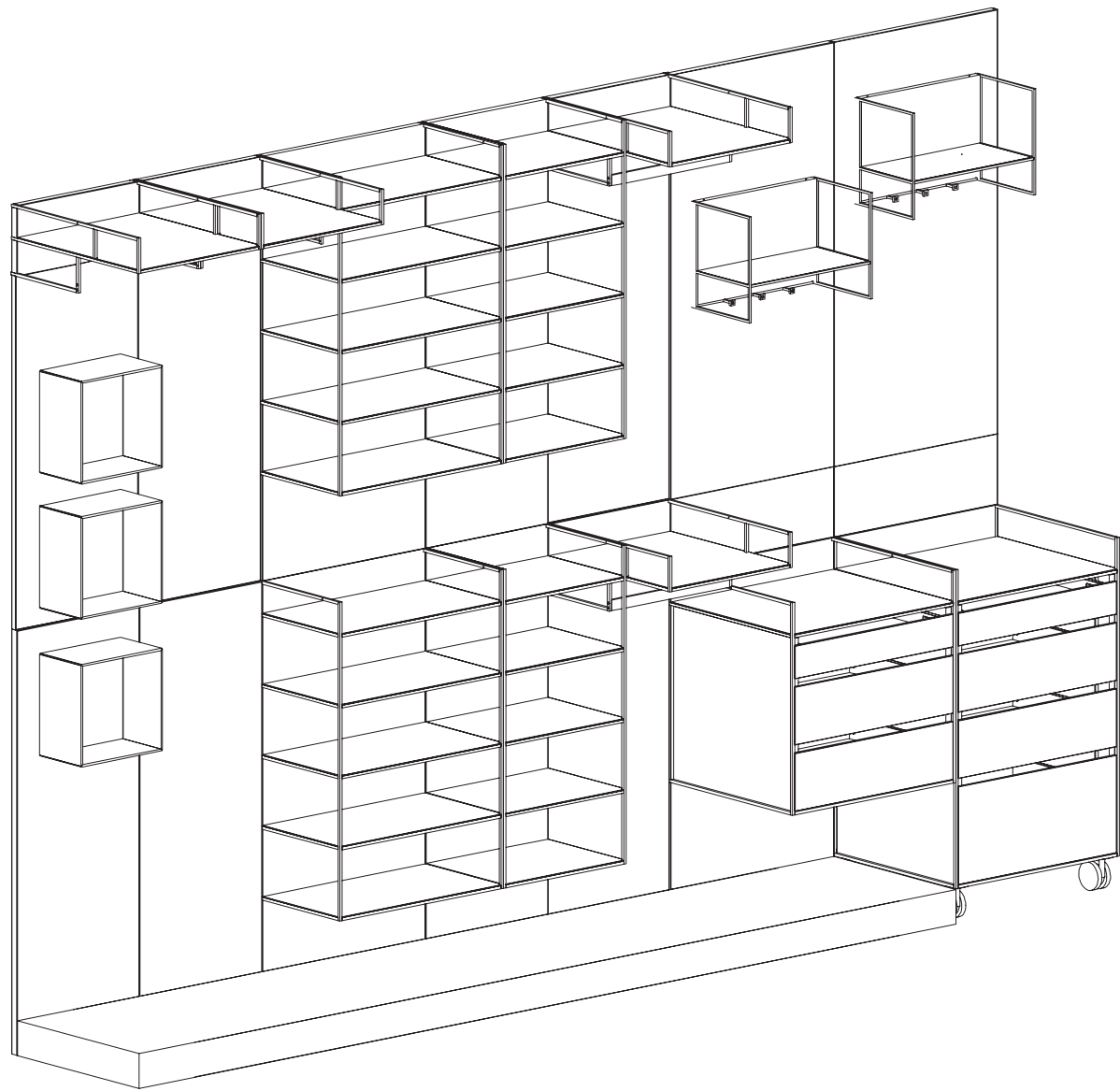



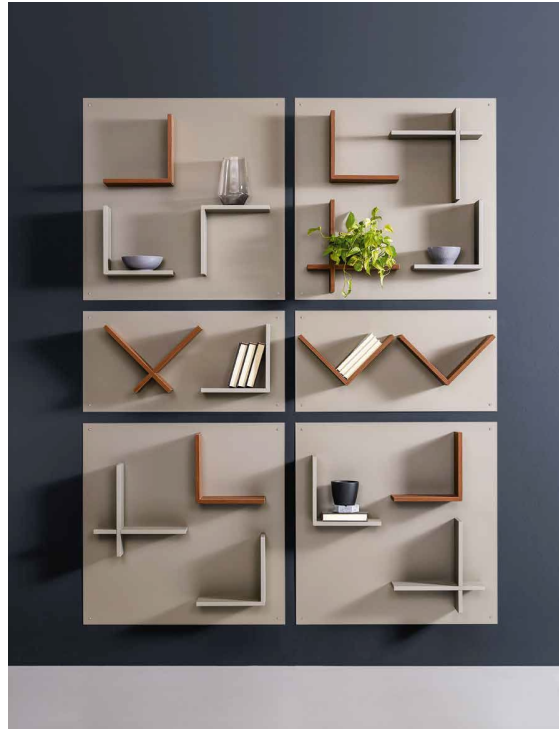

Magnetic Accessory Types

modularWALLCLAD accessories attach magnetically using rare earth magnets. To ensure an extremely strong connection, accessories are broken down by magnet type. Type 1 accessories fasten strongly to metal panels, while Type 2 increases magnetic strength to account for varying material thicknesses by adding more, and stronger, magnets.

TYPE 1 ACCESSORIES

Accessories that attach to metal panels

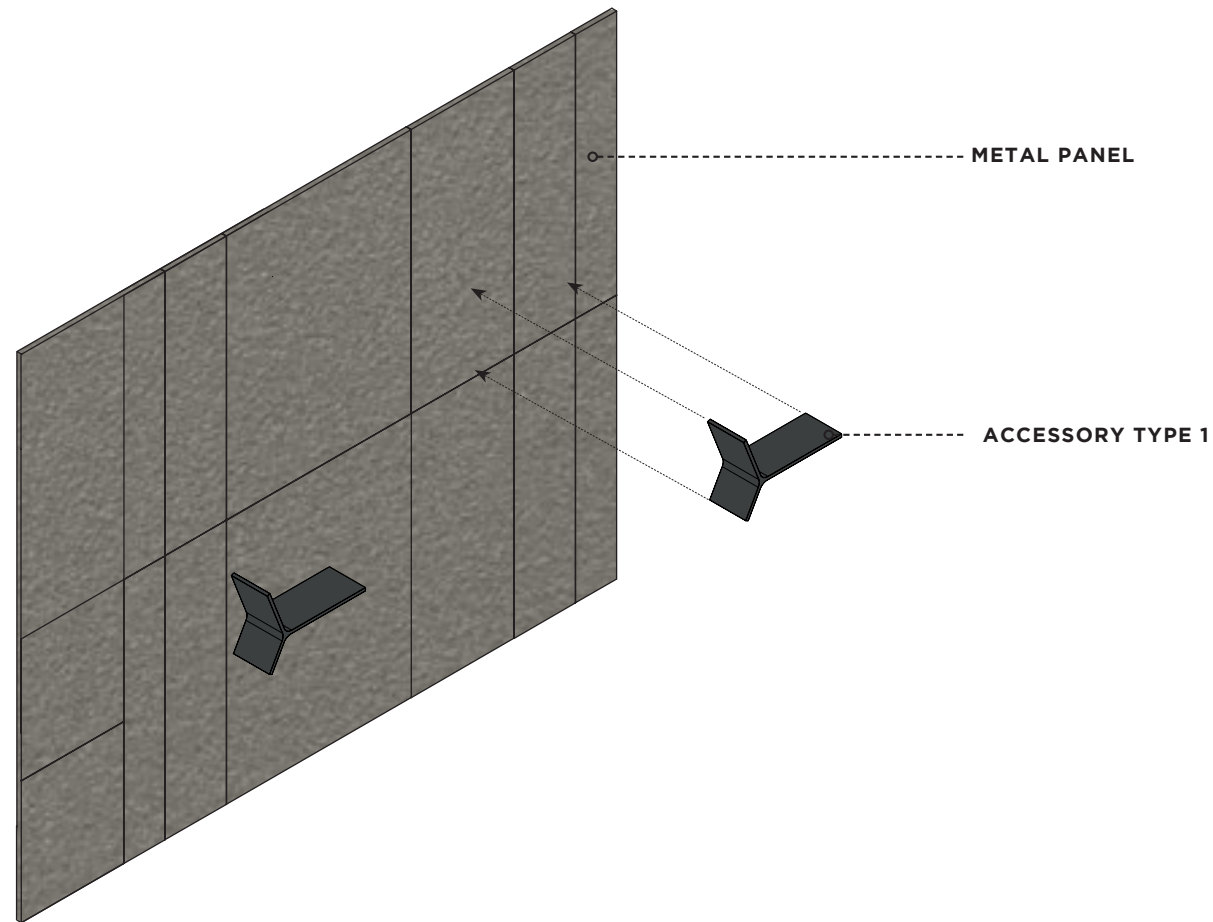

TYPE 2 ACCESSORIES

Accessories that attach to panels of varying materials (veener, ceramics, glass, CHPL).

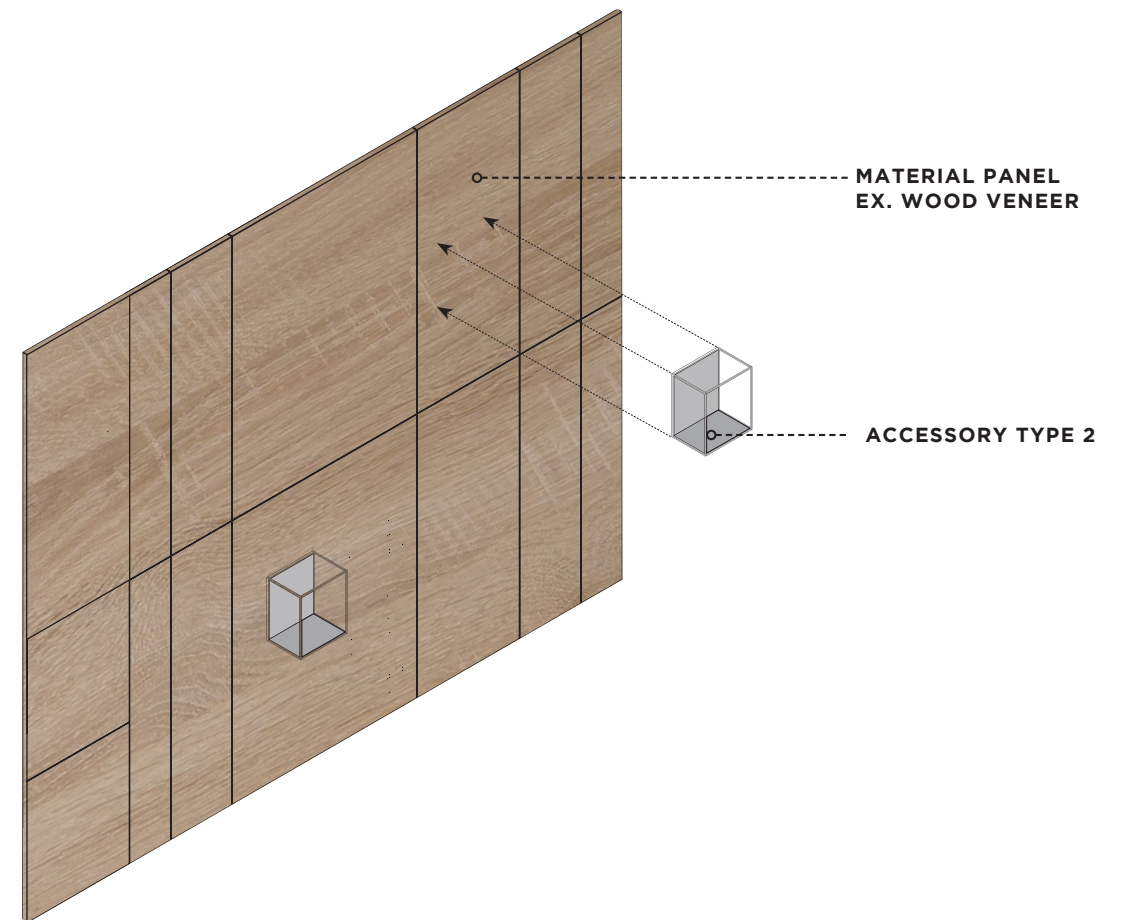

How to Specify Accessories

STEP 1

Select accessory type

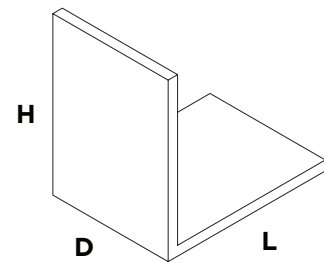
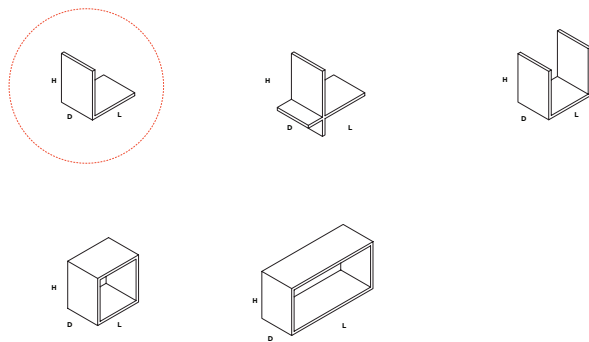

L SHELF

Height: 300mm
 Length: 300mm
 Depth: 150mm (LL04)
 220mm (LL06)

Thickness: 18mm
 Load Capacity: 5kg
 Accessory Type: 1

SPECIFICATION CODE:

LL		
TYPE	DEPTH	FINISH

STEP 2

Select accessory depth or type

NOTE: Some accessories won't have depth or type options!

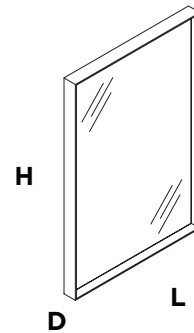

WOOD FRAMED MIRROR

Height: 900mm
 Length: 600mm
 Depth: 40mm

Thickness: 18mm
 Load Capacity: 5kg
 Accessory Type: 1 (02)
 2 (12)

SPECIFICATION CODE:

SP	02 12	
TYPE	ACCESSORY TYPE	FINISH

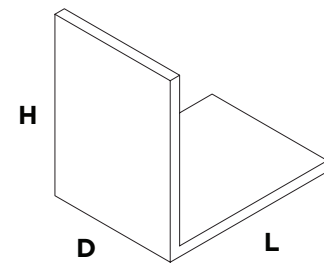

L SHELF

Height: 300mm
 Length: 300mm
 Depth: 150mm (LL04)
 220mm (LL06)

Thickness: 18mm
 Load Capacity: 5kg
 Accessory Type: 1

SPECIFICATION CODE:

LL	04	
TYPE	DEPTH	FINISH

STEP 3

Select Accessory finish

FINISHES

LACQUERED



MELAMINE FACED

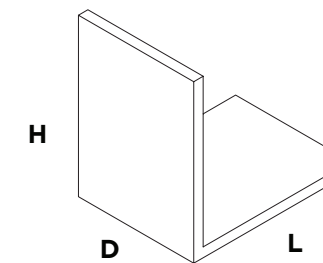
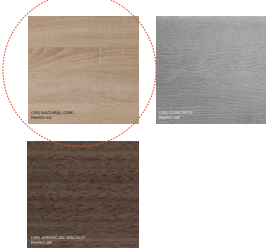

L SHELF

Height: 300mm
 Length: 300mm
 Depth: 150mm (LL04)
 220mm (LL06)

Thickness: 18mm
 Load Capacity: 5kg
 Accessory Type: 1

SPECIFICATION CODE:

LL	04	44
TYPE	DEPTH	FINISH

FINAL SPECIFICATION CODE: LL-04-44

Acoustic Panel Options

FELT ACOUSTIC BAFFLES

Magnetically attached, sound-absorbing panels covered in fire-resistant fabric. Removable and washable. Interior is recycled polyester fiber with sound absorption properties.

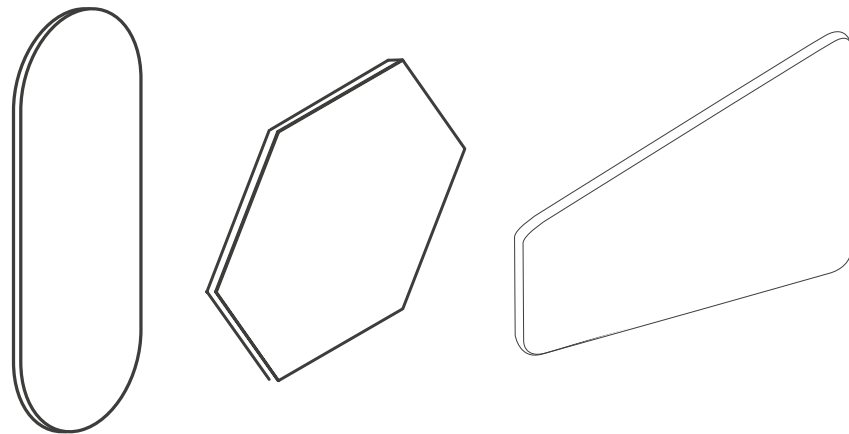

FELT OPTIONS:



magLIGHT > Globe

Rechargeable magnetic lamp with an LED. Run time of 15 hours, 4 light intensities, charge level indicator, and option for operation with other lights.

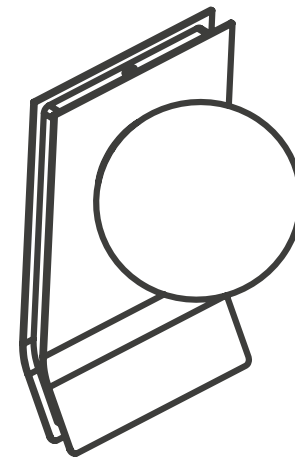

FINISH OPTIONS:

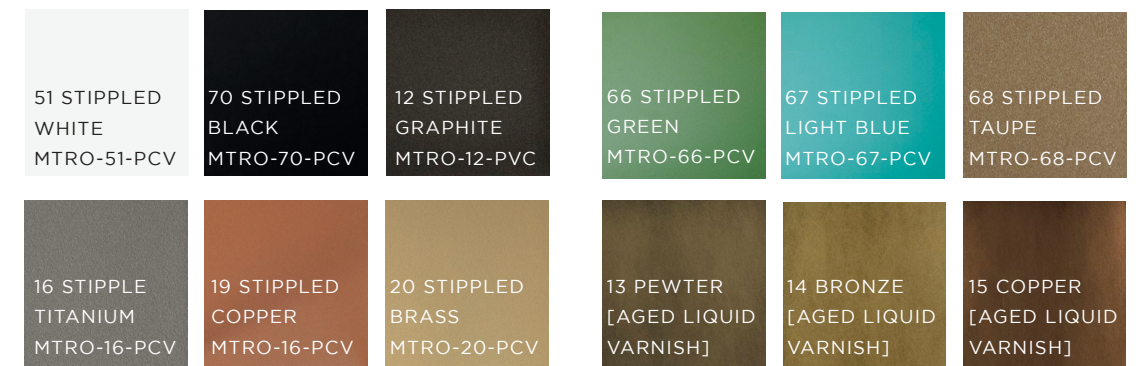

acousticBAFFLE > Oval

PF-02-

Magnetically attached sound-absorbing panels covered in fire-resistant fabric. Removable and washable. Interior is recycled polyester fiber with sound absorption properties.

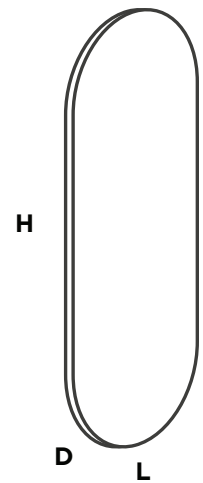

DETAILS

Height: 1200mm [47-1/4"]
 Length: 500mm [19-11/16"]
 Depth: 40mm [1-9/16"]

Accessory Type: 1

EXAMPLE SPECIFICATION CODE: **PF-02-120**

PF	02	SELECT FELT OPTION
LINE	TYPE	FINISH

FELT OPTIONS:

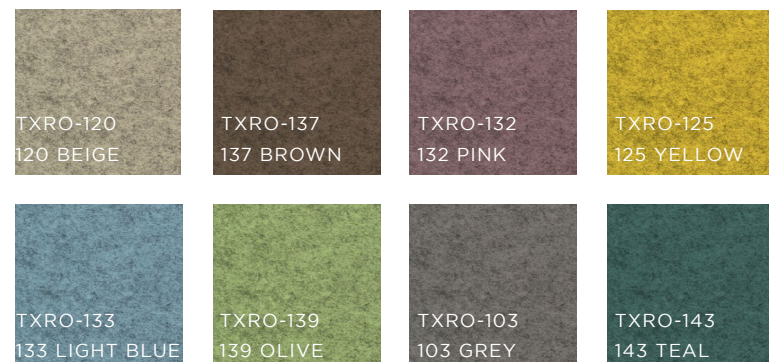

acousticBAFFLE > Hex

PF-01-

Magnetically attached sound-absorbing panels covered in fire-resistant fabric. Removable and washable. Interior is recycled polyester fiber with sound absorption properties.

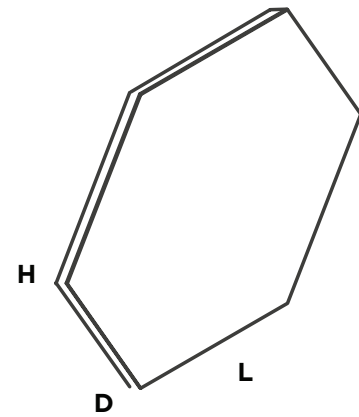

DETAILS

Height: 610mm [24"]
 Length: 695 mm [27-3/8"]
 Depth: 40mm [1-9/16"]
 Accessory Type: 1

EXAMPLE SPECIFICATION CODE: **PF-01-120**

PF	01	SELECT FELT OPTION
LINE	TYPE	FINISH

FELT OPTIONS:

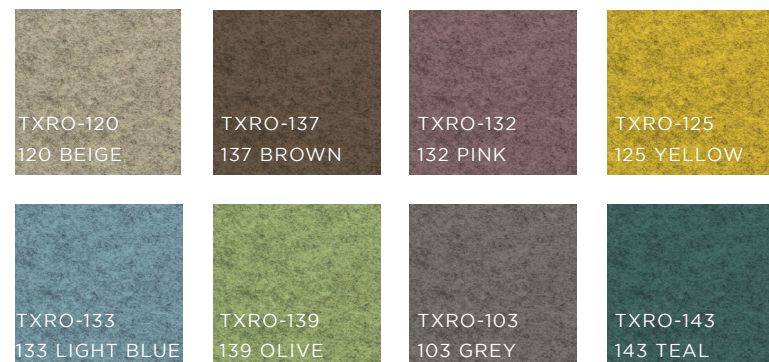

acousticBAFFLE > Angle

PF-05-

Magnetically attached sound-absorbing panels covered in fire-resistant fabric. Removable and washable. Interior is recycled polyester fiber with sound absorption properties.

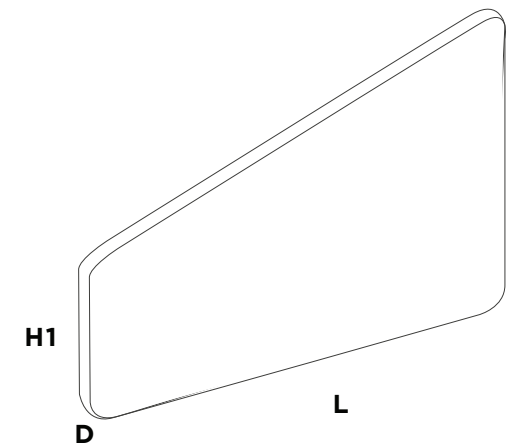

DETAILS

Height 1: 314mm [12-3/8"]
 Height 2: 580mm [22-13/16"]
 Length: 1000mm [39-3/8"]
 Depth: 40mm [1-9/16"]

Accessory Type: 1

EXAMPLE SPECIFICATION CODE: **PF-05-120**

PF	05	SELECT FELT OPTION
LINE	TYPE	FINISH

FELT OPTIONS:

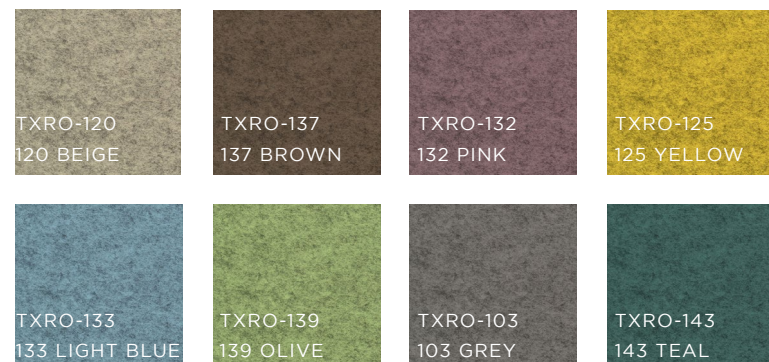

magLIGHT > Globe

LU-

Rechargeable magnetic lamp with an LED. Run time of 15 hours, 4 light intensities, charge level indicator, and option for operation with other lights.

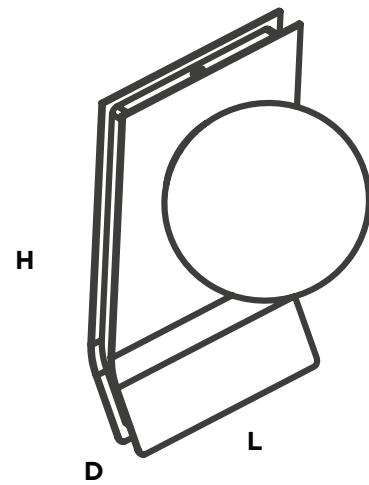

DETAILS

Height: 180 mm [7"]
 Length: 300mm [11-13/16"]
 Depth: 161mm [6-5/16"]

Accessory Type: 1 (20)
 2 (21)

Light Features:
 - Removable lithium battery 5500 MA/h - 3.7V
 - Up to 15 Hours runtime
 - Battery charger included
 Color Temperature 3000K (warm light)

EXAMPLE SPECIFICATION CODE: **LU-20-51**

LU	20	SELECT FINISH OPTION
	21	
LINE	TYPE	MODEL/ID

FINISH OPTIONS:

51 STIPPLED WHITE MTRO-51-PCV	70 STIPPLED BLACK MTRO-70-PCV	12 STIPPLED GRAPHITE MTRO-12-PVC	66 STIPPLED GREEN MTRO-66-PCV	67 STIPPLED LIGHT BLUE MTRO-67-PCV	68 STIPPLED TAUPE MTRO-68-PCV
16 STIPPLE TITANIUM MTRO-16-PCV	19 STIPPLED COPPER MTRO-16-PCV	20 STIPPLED BRASS MTRO-20-PCV	13 PEWTER [AGED LIQUID VARNISH]	14 BRONZE [AGED LIQUID VARNISH]	15 COPPER [AGED LIQUID VARNISH]

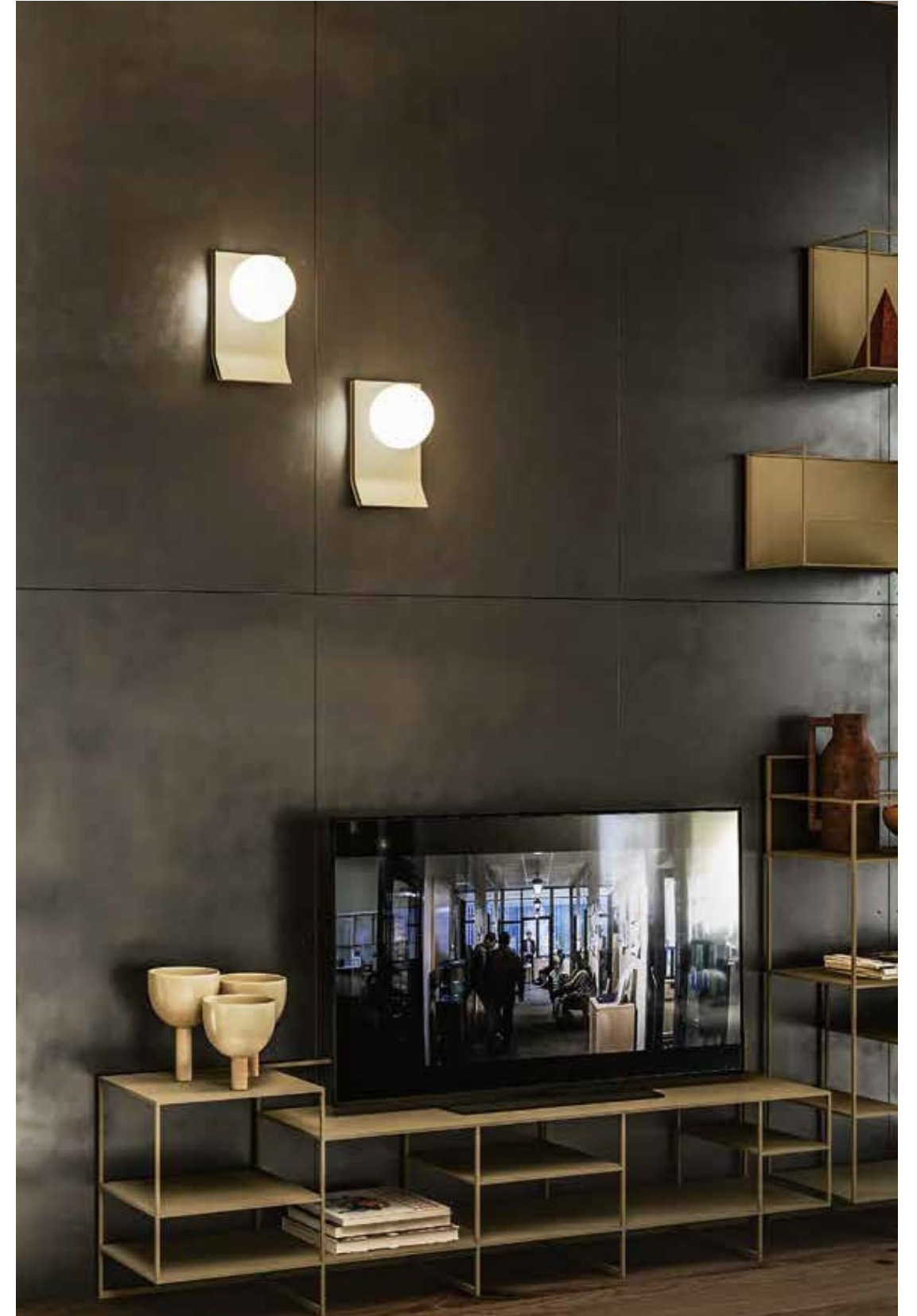

Accessories

FINISHES

LACQUERED



MELAMINE FACED

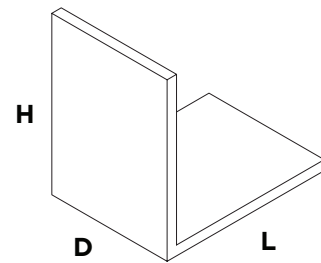
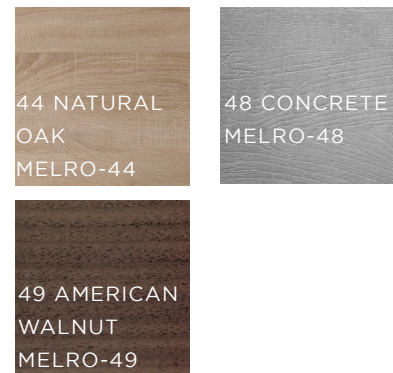

L SHELF

Height: 300mm [11-13/16"]
 Length: 300mm [11-13/16"]
 Depth: 150mm [5-15/16"] (04)
 220mm [8-11/16"] (06)

Thickness: 18mm [11/16"]
 Load Capacity: 5kg [-11 lbs.]
 Accessory Type: Type 1

SPECIFICATION CODE:			
LL	04		
	06		
TYPE	DEPTH	FINISH	

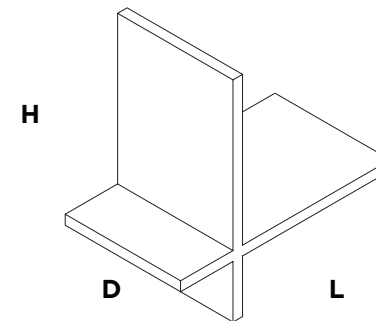

T SHELF

Height: 400mm [15-3/4"]
 Length: 400mm [15-3/4"]
 Depth: 150mm [5-15/16"] (10)
 220mm [8-11/16"] (12)

Thickness: 18mm [11/16"]
 Load Capacity: 5kg [-11 lbs.]
 Accessory Type: Type 1

SPECIFICATION CODE:		
TL	10	
	12	
TYPE	DEPTH	FINISH

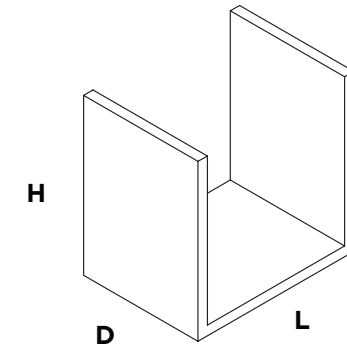

U SHELF

Height: 300mm [11-13/16"]
 Length: 300mm [11-13/16"]
 Depth: 220mm [8-11/16"] (01)

Thickness: 18mm [11/16"]
 Load Capacity: 5kg [-11 lbs.]
 Accessory Type: Type 1

SPECIFICATION CODE:		
UL	01	
TYPE	DEPTH	FINISH

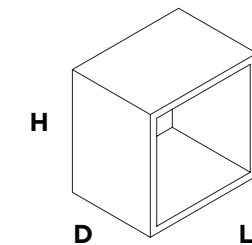

CUBE SHELF

Height: 300mm [11-13/16"]
 Length: 300mm [11-13/16"]
 Depth: 150mm [5-15/16"] (01)
 220mm [8-11/16"] (02)

Thickness: 18mm [11/16"]
 Load Capacity: 5kg [-11 lbs.]
 Accessory Type: Type 1

SPECIFICATION CODE:		
CL	01	
	02	
TYPE	DEPTH	FINISH

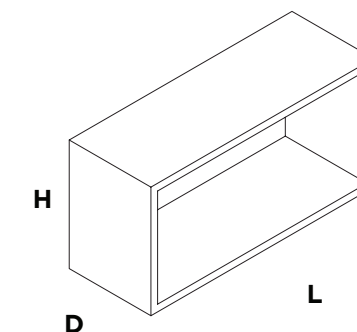

RECTANGLE SHELF

Height: 300mm [11-13/16"]
 Length: 600mm [23-5/8"]
 Depth: 150mm [5-15/16"] (01)
 220mm [8-11/16"] (02)

Thickness: 18mm [11/16"]
 Load Capacity: 7kg [-15 lbs.]
 Accessory Type: Type 1

SPECIFICATION CODE:		
RL	01	
	02	
TYPE	DEPTH	FINISH

Accessories

FINISHES

LACQUERED



MELAMINE FACED

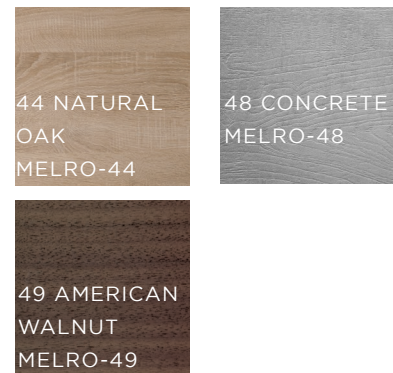

Y SHELF

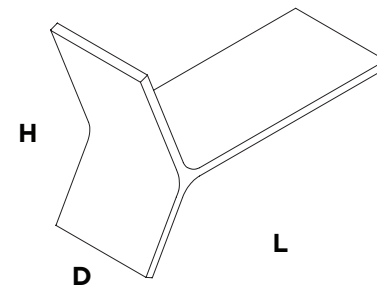

Height: 434mm [17"]
 Length: 596mm [23-7/16"]
 Depth: 220mm [8-11/16"] (14)
 Thickness: 18mm [11/16"]
 Load Capacity: 5kg [-11lbs.]
 Accessory Type: Type 1

SPECIFICATION CODE:			
TYPE	DEPTH	FINISH	
		YP	14

WOOD FRAMED MIRROR

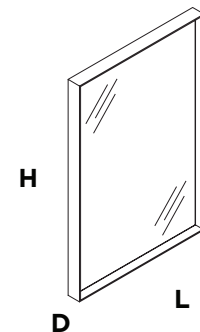

Height: 900mm [35-7/16"]
 Length: 600mm [23-5/8"]
 Depth: 40mm [1-9/16"]
 Thickness: 18mm [11/16"]
 Load Capacity: 5kg [-11lbs.]
 Magnetic Type: Type 1 (03)
 Type 2 (13)

SPECIFICATION CODE:		
TYPE	ACCESSORY TYPE	FINISH
	03 13	

Accessories

FINISHES

METAL

51 STIPPLED WHITE MTRO-51-PCV	70 STIPPLED BLACK MTRO-70-PCV
16 STIPPLE TITANIUM MTRO-16-PCV	19 STIPPLED COPPER MTRO-16-PCV
12 STIPPLED GRAPHITE MTRO-12-PVC	20 STIPPLED BRASS MTRO-20-PCV

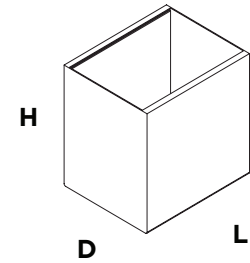

SQUARE STORAGE

Height: 200mm [7-7/8"]
Length: 200mm [7-7/8"]
Depth: 162mm [6-3/8"]

Load Capacity: 7kg [-15lbs.]
Accessory Type: Type 1 (01)
Type 2 (11)

SPECIFICATION CODE:

SW	01	
	11	
<small>TYPE</small>	<small>DEPTH</small>	<small>FINISH</small>

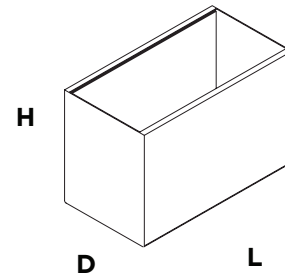

RECTANGLE STORAGE

Height: 200mm [7-7/8"]
Length: 300mm [11-13/16"]
Depth: 162mm [6-3/8"]

Load Capacity: 10kg [-22lbs.]
Accessory Type: Type 1 (02)
Type 2 (12)

SPECIFICATION CODE:

TL	02	
	12	
<small>TYPE</small>	<small>DEPTH</small>	<small>FINISH</small>

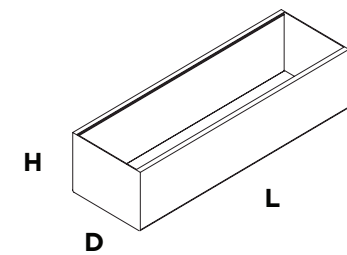

WIDE STORAGE

Height: 120mm [4-3/4"]
Length: 500mm [19-11/16"]
Depth: 162mm [6-3/8"]

Load Capacity: 10kg [-22lbs.]
Accessory Type: Type 1 (03)
Type 2 (13)

SPECIFICATION CODE:

SW	03	
	13	
<small>TYPE</small>	<small>DEPTH</small>	<small>FINISH</small>

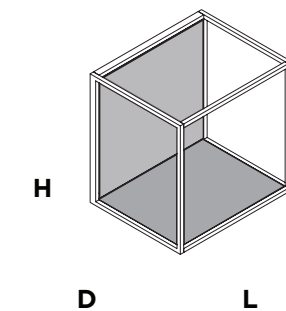

WIRE SHELF

Height: 200mm [7-7/8"]
Length: 200mm [7-7/8"]
Depth: 162mm [6-3/8"]

Load Capacity: 7kg [-15lbs.]
Accessory Type: Type 1 (01)
Type 2 (11)

SPECIFICATION CODE:

CA	01	
	11	
<small>TYPE</small>	<small>DEPTH</small>	<small>FINISH</small>

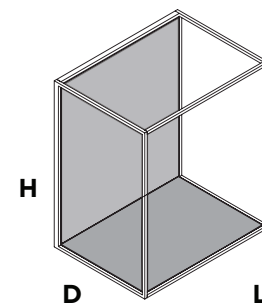

RECTANGLE WIRE SHELF

Height: 350mm [13-3/4"]
Length: 300mm [11-13/16"]
Depth: 220mm [8-11/16"]

Load Capacity: 10kg [-22lbs.]
Accessory Type: Type 1 (02)
Type 2 (12)

SPECIFICATION CODE:

CA	02	
	12	
<small>TYPE</small>	<small>DEPTH</small>	<small>FINISH</small>

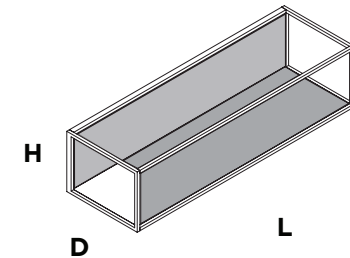

WIDE WIRE SHELF

Height: 120mm [4-3/4"]
Length: 500mm [19-11/16"]
Depth: 162mm [6-3/8"]

Load Capacity: 10kg [-22lbs.]
Accessory Type: Type 1 (03)
Type 2 (13)

SPECIFICATION CODE:

CA	03	
	13	
<small>TYPE</small>	<small>DEPTH</small>	<small>FINISH</small>

Accessories

FINISHES

METAL

51 STIPPLED WHITE MTRO-51-PCV	70 STIPPLED BLACK MTRO-70-PCV
16 STIPPLE TITANIUM MTRO-16-PCV	19 STIPPLED COPPER MTRO-16-PCV
12 STIPPLED GRAPHITE MTRO-12-PVC	20 STIPPLED BRASS MTRO-20-PCV

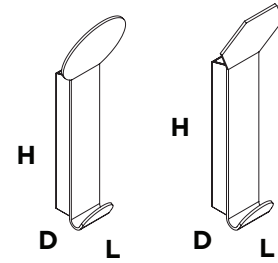

HANGERS

Height: 293mm [11-1/2"]
Length: 96mm [3-3/4"]
Depth: 59mm [2-5/16"]

Load Capacity: 6kg [-13lbs.]
Accessory Type: Type 2
Design: Round (01), Hexagonal (11)

SPECIFICATION CODE:

MP	01	
	11	
TYPE	DEPTH	FINISH

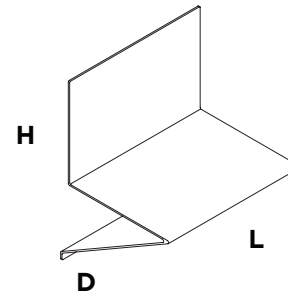

CLIP SHELF

Height: 358mm [14-1/16"]
Length: 290mm [11-7/16"] (01)
435mm [17-1/8"] (02)
580mm [22-13/16"] (03)
Depth: 241mm [9-7/16"]

Load Capacity: 10kg [-22lbs.]
Accessory Type: Type 2

SPECIFICATION CODE:

ME	01	
	02	
	03	
TYPE	DEPTH	FINISH

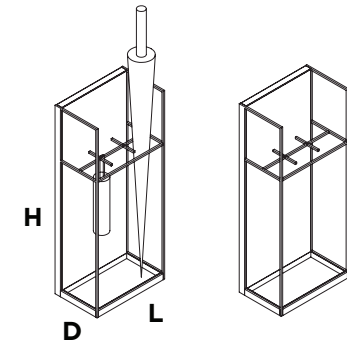

UMBRELLA STAND

Height: 180mm [7-1/16"]
Length: 290mm [11-7/16"]
Depth: 180mm [7-1/16"]

Accessory Type: Type 1 (11)
Type 2 (12)

SPECIFICATION CODE:

CE	11	
	12	
TYPE	DEPTH	FINISH

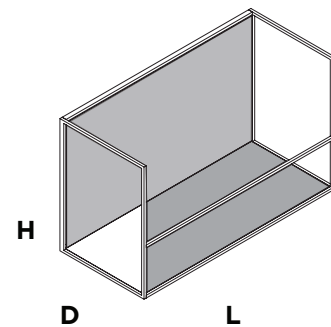

CART SHELF

Height: 300mm [11-13/16"]
Length: 500mm [19-11/16"]
Depth: 220mm [8-11/16"]

Load Capacity: 10kg [-22lbs.]
Accessory Type: Type 1 (04)
Type 2 (14)

SPECIFICATION CODE:

CA	04	
	14	
TYPE	DEPTH	FINISH

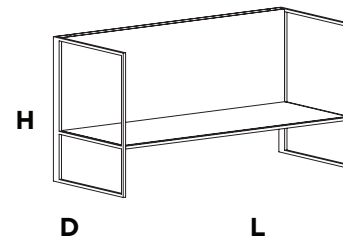

FRAME SHELF

Height: 300mm [11-13/16"]
Length: 290mm [11-7/16"] (04)
435mm [17-1/8"] (05)
580mm [22-13/16"] (06)
Depth: 240mm [9-7/16"]

Load Capacity: 10kg [-22lbs.]
Accessory Type: Type 2

SPECIFICATION CODE:

ME	04	
	05	
	06	
TYPE	DEPTH	FINISH

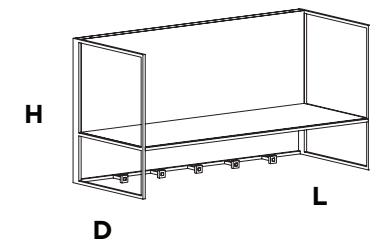

FRAME HANGER SHELF

Height: 300mm [11-13/16"]
Length: 290mm [11-7/16"] (07) [2 Hooks]
435mm [17-1/8"] (08) [3 Hooks]
580mm [22-13/16"] (09) [5 Hooks]
Depth: 240mm [9-7/16"]

Load Capacity: 10kg [-22lbs.]
Accessory Type: Type 2

SPECIFICATION CODE:

ME	07	
	08	
	09	
TYPE	DEPTH	FINISH

Accessories

FINISHES

METAL

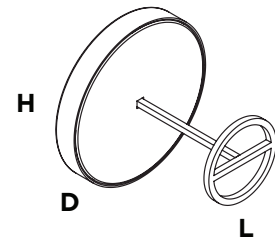

HAT HANGER

Height: 160mm [6-5/16"]
 Length: 160mm [6-5/16"]
 Depth: 148mm [5-13/16"]
 Load Capacity: 6kg [-13lbs.]
 Accessory Type: Type 2

SPECIFICATION CODE:

ME	13	
TYPE	DEPTH	FINISH

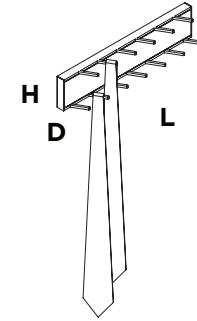

TIE HANGER

Height: 90mm [3-1/2"]
 Length: 435mm [17-1/8"]
 Depth: 65mm [2-1/2"]
 Load Capacity: 10kg [-22lbs.]
 Accessory Type: Type 2

SPECIFICATION CODE:

ME	14	
TYPE	DEPTH	FINISH

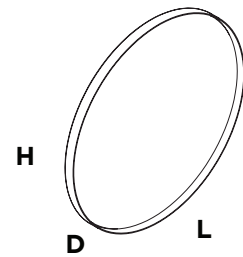

ROUND MIRROR

(14) 400mm [15-3/4"] Diameter / Accessory Type 1
 (12) 500mm [19-11/16"] Diameter / Accessory Type 1
 (04) 400mm [15-3/4"] Diameter / Accessory Type 2
 (02) 500mm [19-11/16"] Diameter / Accessory Type 2 Depth: 42mm [1-11/16"]

SPECIFICATION CODE:

MP	14	
	12	
	04	
	02	
TYPE	DEPTH	FINISH

T.V. Mounts

FINISHES

LACQUERED

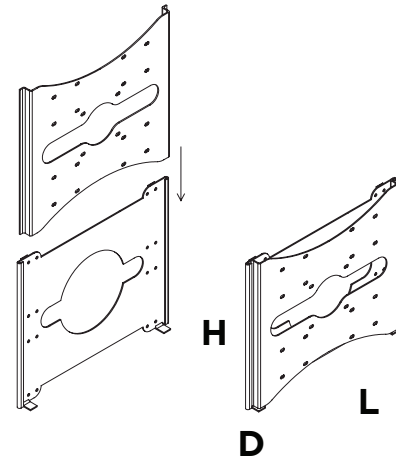

SMALL TV MOUNT

Height: 275mm [10-13/16"]
 Length: 322mm [12-11/16"]
 Depth: 28mm [1-1/8"]

Load Capacity: 20kg [-44 lbs.]
 Accessory Type: Type 1
 VESA 200/200 Mounting

SPECIFICATION CODE:

AV	0170	70
<small>TYPE</small>	<small>DEPTH</small>	<small>FINISH</small>

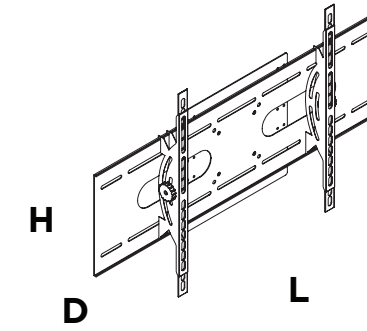

LARGE TV MOUNT

Height: 530mm [20-7/8"]
 Length: 810mm [31-7/8"]
 Depth: 62mm [2-7/16"]

Load Capacity: 20kg [-44 lbs.]
 Accessory Type: Type 1
 VESA 200/200 Mounting
 Recommend for screens from 37" to 60"

SPECIFICATION CODE:

AV	0270	70
<small>TYPE</small>	<small>DEPTH</small>	<small>FINISH</small>

CARVART®