

INTEGRA

Electronic self-sufficient washbasins

Integra is a sleek Italian-designed integrated system of solid surface and glass washbasins, faucets and high-tech multiconsoles. Extremely functional, durable and practical, Integra has the look of a modern piece of furniture.

The smooth, flowing basin shapes allude to the fluidity of water and juxtapose with the geometric lines and chromed surfaces of faucets and multiconsole dispenser units to create a harmonious contemporary visual. The self-contained washbasins can be installed individually or in rows of two or three.

All mechanical elements of the trough-type basin are recessed behind the backsplash and not under the basin for a streamlined appearance. The water spouts can be removed for ease of inspection and maintenance. Soap is easy to supply, as is the servicing for maintenance.

The thoroughly modern materials and fluid styling make it a design focal point but Integra also offers important hygienic benefits in high-traffic public bathrooms because users don't need to touch the hardware.

SOLID



- Sleek design for heavy-duty usage
- Automatic functionality
- Acrylic solid surface material
- Trough washbasin
- Wall-mounted on galvanized steel built-in wall supports
- One, two or three washing positions
- Integrated Multiconsole with exposed spouts for electronic soap dispenser, water faucet and hand dryer
- Exposed spouts are hand-finished chrome
- Glass or anodized aluminum shelves for placement of small personal objects

GLASS



- Handcrafted colored glass washbasin with attached glass backsplash
- One, two or three continuous positions
- Wall-mounted on visible, polished stainless steel bracket supports
- Integrated Multiconsole with exposed spouts for electronic soap dispenser, water faucet and hand dryer
- Exposed spouts and drain are hand-finished chrome
- Glass or anodized aluminum shelves for placement of small personal objects
- Can stand-alone with wall-mounted electronic faucets

INTEGRA

INTEGRAglass > V is a combination of a continuous handcrafted glass washbasin supported on polished stainless steel visible brackets, with an attached glass backsplash that supports the sensors, a glass shelf, and exposed square spouts for an electronic soap dispenser, water faucet and hand dryer.

The glass washbasin is thermoformed with round corners from 5/8" glass, available in various RAL color options.

Stylish mirrors are fitted with backlit LED lights that shows users where to place their hands by illuminating the designations of "Soap," "Water" and "Air."

INTEGRAglass > V



Electronic faucets and soap dispensers

Single-hole and wall-mounted automatic water faucets and soap dispensers in chrome and stainless steel.

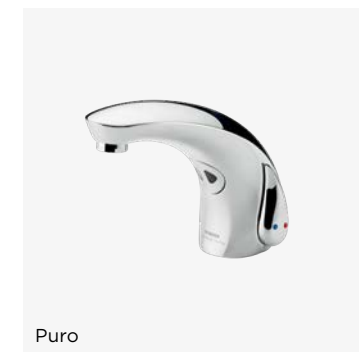
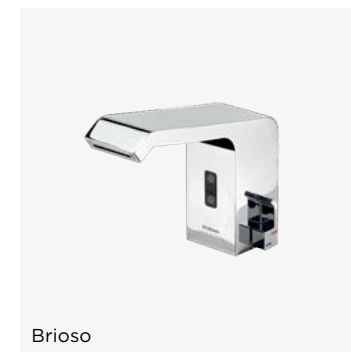
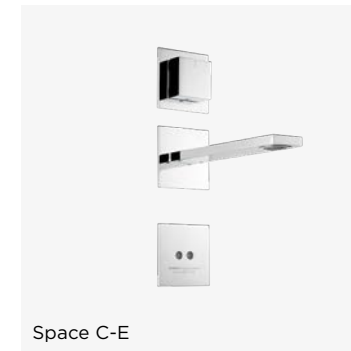

INTEGRA

INTEGRAglass > V

Handcrafted colored glass washbasin with Multiconsole exposed spouts and glass shelf

Options

- Mirror with perimeter LED lights
- Glass shelf, as seen in INTEGRAsolid > S

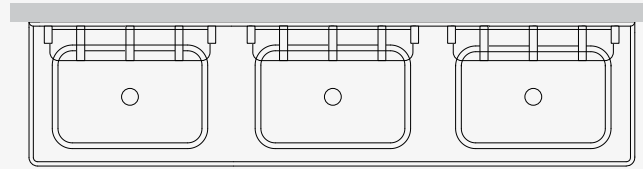
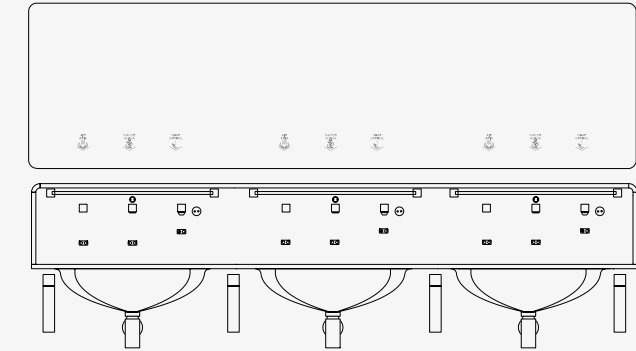
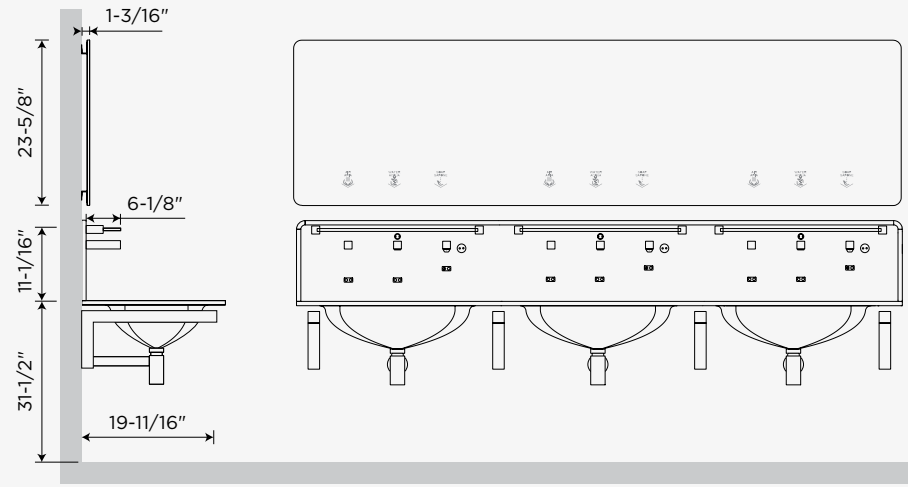

Single Washbasin
Double Washbasin
Triple Washbasin

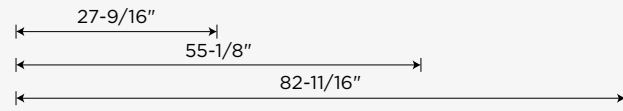

Colors

CARVART has curated glass colors and anodized aluminum finishes to assist in your design process. Should you require more options, contact CARVART or your sales representative, and we will partner with you to select from the other colors that are available.

Glass Finishes

Available in both Smooth finish, when a high-gloss reflective look is desired, or an Etch finish which is non-reflective and minimizes fingerprints.

Glass Colors

Available in 26 standard colors, other RAL colors may be available subject to approval of samples.

The colors reproduced in this brochure have been matched as closely as print technology allows.

Hardware Colors

Hardware is available in anodized aluminum.

GLASS

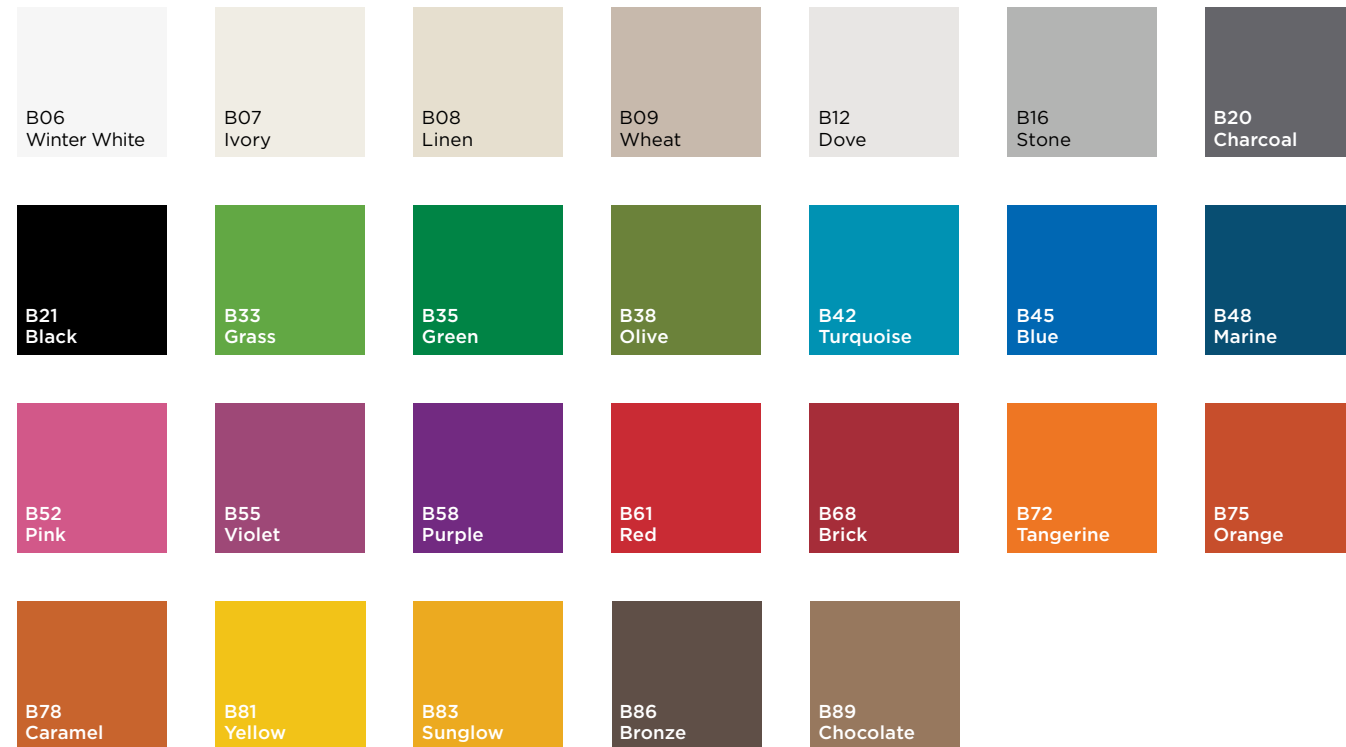

GLASS (METALLICS)

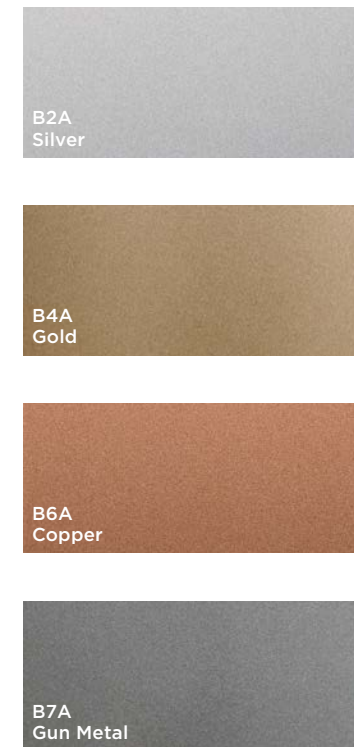

GLASS SURFACE OPTIONS

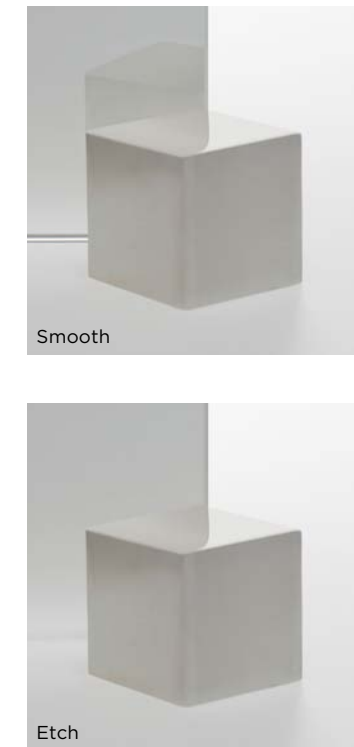

CHPL (LOCKER DOORS/CUBICLES)



CHPL BODY (LOCKERS)



HARDWARE

Materials

GRAPHICglass

This product line features our custom print capability which is the best quality in the market. With 1440 dpi clarity and vibrant color hues, your inspiration becomes reality.

From a photograph to digital artwork to a unique pattern, you can express your creativity. Make a statement. Create a mood. Communicate a lifestyle.

cHPL Wood Finishes

Curated from a classical and historical collection, our cHPL panels are offered in a wide range of "woodgrains."

GLASS



cHPL



385



381



1621



626



389



391



606

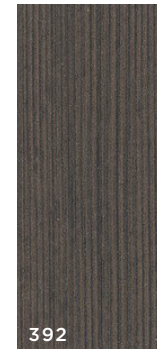

392



524



1354



382



662

Materials

Stone

Pale colors and delicate nuances inspired by wet plaster and industrial concrete. Soft materials with a strong contemporary spirit, icons of sophisticated design.

Finishing effects of the porcelain sheets may vary from panel to panel. Sample colors are considered indicative.

Marble

By definition, shining metamorphic rocks that diversify in changing energetic veins.

STONE

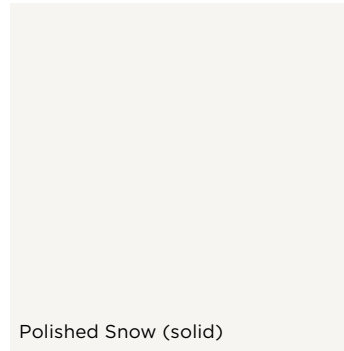

Polished Snow (solid)

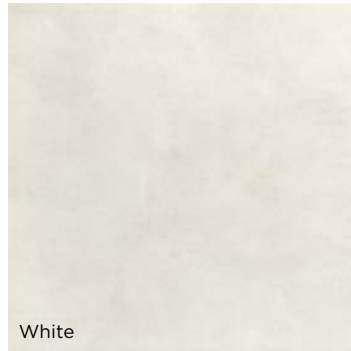

White



Gray



Dove Gray

MARBLE (POLISHED)



Calacatta Gold Vein



Orobic Gray



Charcoal Gray



Slate Gray

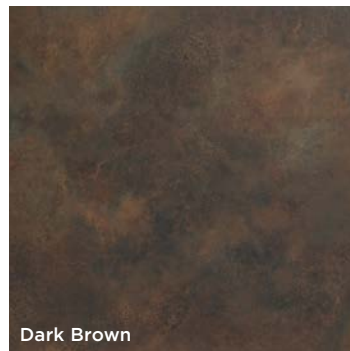

Dark Brown

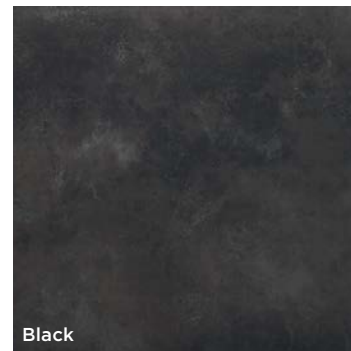

Black

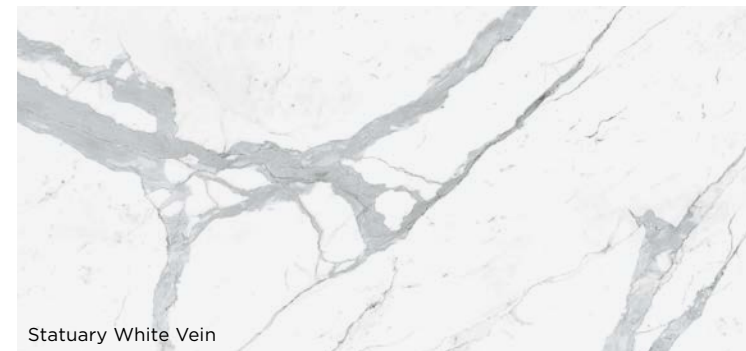

Statuary White Vein

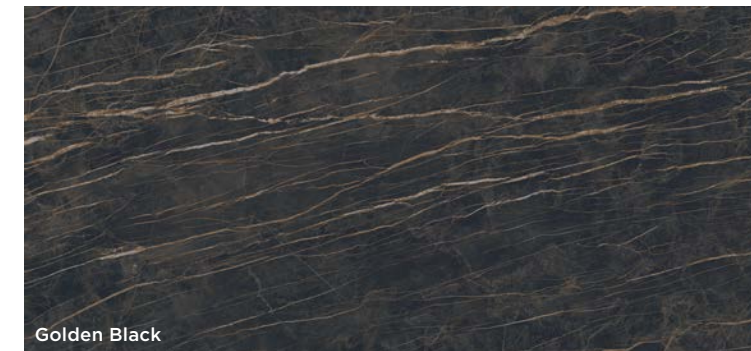

Golden Black

Handcrafted Technology

With unalterable belief, that our stance is the balanced choice to pursue excellence, we work passionately to ensure that every final product can reveal and project the story of Italian design culture and human artisan mastery.

“Handcrafted Technology” is an attitude, where fulfillment is a journey of constant exploration and not a destination. It’s a philosophy and way of life.

Today, we’re proud to function, research, design, continuously upgrade our workforce skills and production by using specially adopted programs, machinery,

and technological solutions bonded with traditional tool elements, which have been formulated, developed and controlled through dedicated work, knowledge and craft experimentation. In this way, we motivate artisan persistence and insist in the “handcrafted final mastery touch” for all stages of our production.

“Handcrafted Technology” predicates that inventive sensitivity and even more, necessity, must honor the final result by merging all human life standards and values with technology and progress.

The information contained in this PDF has been accurately controlled. CARVART and SOEMA are not responsible for any possible inaccuracies and reserves the right to make any technical and aesthetic changes to the products without notice.

