

Workstations > GRIP

(GS-SW-GP)

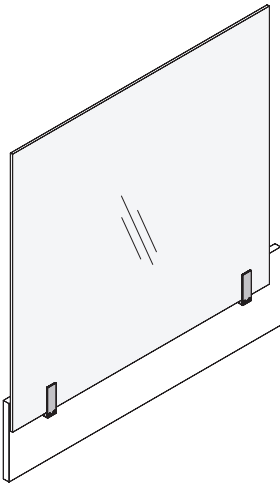

TYPICAL FRONT DETAIL

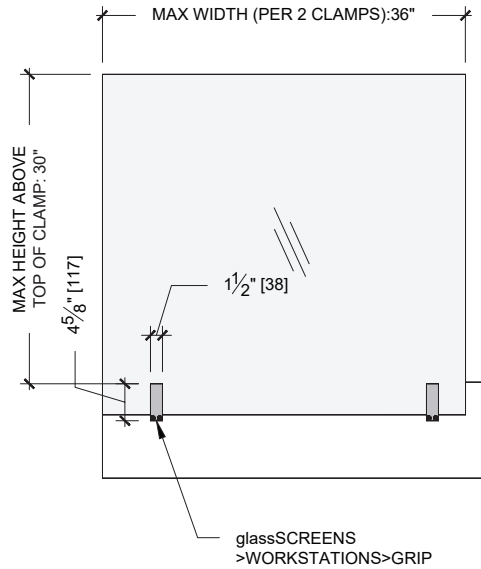

TYPICAL ELEVATION

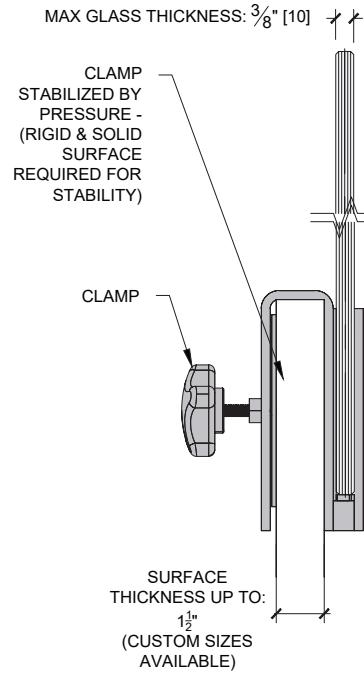

TYPICAL VERTICAL SECTION

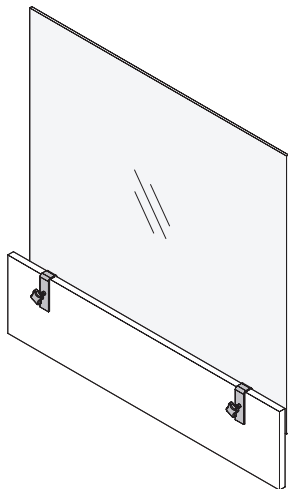

TYPICAL REAR DETAIL

Specifications

Workstations>GRIP

CARVART's benching screens offer a timeless architectural design that are flexible and adaptable, while providing hygienic protection for our ever-changing workplace. The sleek aesthetics blend into any space and are ideal for protection and engagement with non-porous, scratch resistant tempered glass that is increasingly durable, ensuring a greater product longevity.

APPLICATIONS –

Space division between working areas

HARDWARE MATERIALS/FINISHES –

Silver Powder Coated
*Other Powder Coated Colors available upon request

PANEL WIDTHS (OVERALL MAXIMUM) –

Max Width (per 2 clamps): 36"
Max Width (per 3 clamps): 72"

PANEL HEIGHTS –

Max Height (1/4" thick glass): 24"
Max Height (3/8" thick glass): 30"

MOUNTING OPTIONS –

Clamp, Mechanically Fastened

MAX TABLE THICKNESS –

1-1/2"

GLASS THICKNESSES –

1/4" - 3/8"

WARRANTY –

10 Year Limited Warranty

Specification Code: **GS-SW-GP**

GS	SW	GP
LINE	TYPE	MODEL/ID